



A full range of services...
a complete range of products and applications

ALFA SURFACES

Innovation, design & sustainability with
viable practices from Alfa Wood Group



Although it has been a long course with many obstacles and challenges since 1981, we always felt that we still have a long way ahead of us, committed to quality, every day, in every detail.

Alfa Wood Group is one of the leading wood industries in Greece and one of the most prominent in the Balkans. Our industrial facilities are located in four different locations in Greece, each factory having a unique specialization in its field:

1. Grevena Factory (Raw Fiberboard (MDF) - Veneered fiberboard panels (MDF) - Laminate flooring - Lacquered fiberboard (MDF) - Melamine faced Panels -1MW power using biomass
2. Larissa Factory (Melamine faced Panels - Veneered particleboard and fiberboard panels – Worktops -Door frames and Profiles- Interior Doors - Acoustic Panels - Wall Cladding - 1MW power using biomass
3. Nevrokopi Drama Factory (Wood pellet & Briquette - 4.5MW power using biomass and solar panels).
4. Komotini Factory (Chipboard production, impregnation of printed papers and Melamine faced Panels).

The production lines in our factories spread over a 408.000sqm area, of which 81.000 sq.m. are covered. Being the sole MDF panels producer in Greece, we also provide a wide range of products such as coated and melamine faced panels, laminate flooring etc. (counting more than 220,000m³ annually). Our collections of melamine or veneer panels are combined with hundreds of designs and a wide range of finishes, which create a great end result.

At **Alfa Wood Group** we are proud for our part in environmental issues and in the entire supply chain of wood industry, in the production of wood-based panels and biomass

AlfaWood APP
★★★★★

Check Our Awesome **New App**, You have instant access to design tools, media, information and more on your mobile devices!

DOWNLOAD THE APP NOW

GET IT ON Google Play | Download on the App Store | EXPLORE IT ON AppGallery

Three mobile devices are shown: a smartphone displaying the app's main menu with icons for PRODUCTS, ALFA TOOLS, CONTACT, VIDEOS, and CLUB; a tablet displaying a grid of product categories including ALFA SURFACES, ALFA MELD, ALFA FLOORING, ALFA BUILDING, ALFA FOS, ALFA INDOOR, ALFA BUILDING, and ALFA PELLETS; and another smartphone displaying a camera interface with the text 'Take Photo of My Room' and a photo of an open kitchen.

INDEX

- 06** Products
- 47** Textures
- 51** Alfa Surfaces
- 110** Alfa Tops
- 126** Alfa Combo
- 130** Alfa Compact
- 132** Environment
- 134** Certifications

Complete range of products

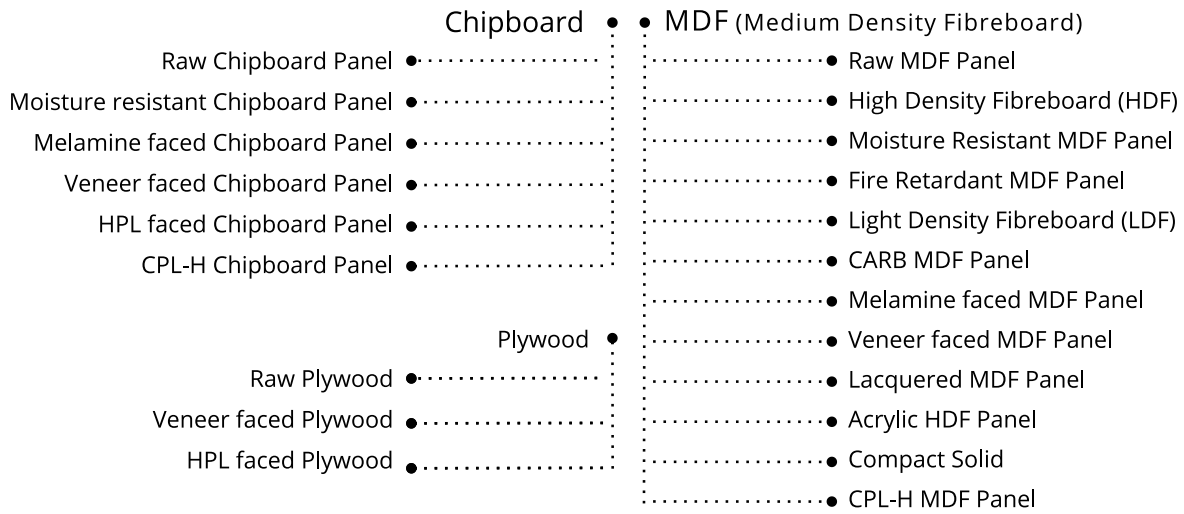

ALFA SURFACES

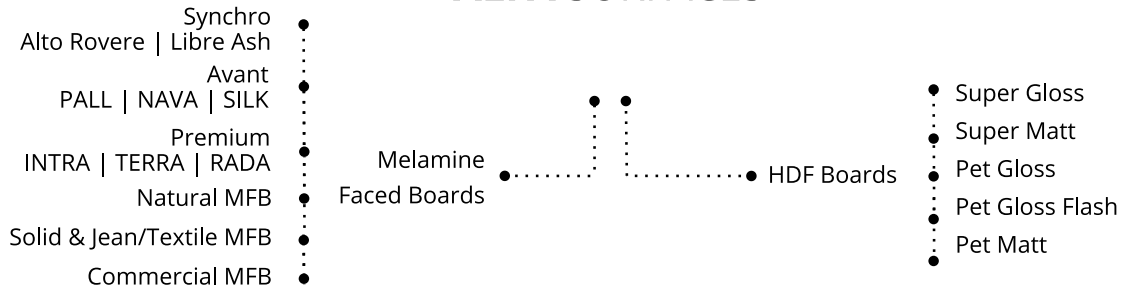

ALFA XILO



ALFA TOPS



ALFA INDOOR



ALFA FLOORING

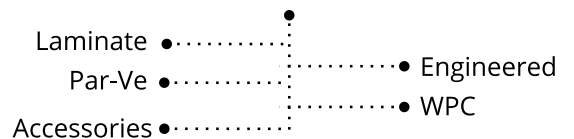

Wall Decoration

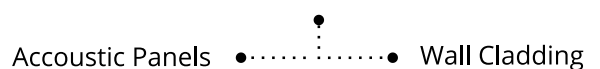

ALFA BUILDING

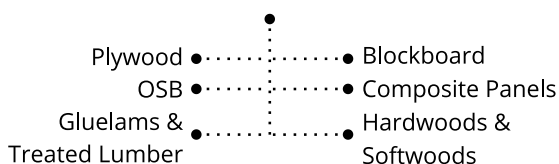

ALFA ENERGY

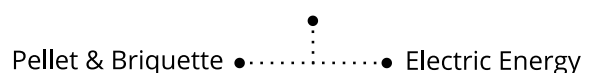

For any project or construction ...

One company, numerous solutions

We have a complete range of wood products with unlimited applications and combinations of materials, all our products are combined with each other, making it easier for Architects, Designers and Furniture Producers to unfold their creativity.

Our wide range of products provides endless possibilities.

We cover all your needs, construction of interior furniture, with our alfa panels & alfa surfaces, to the interior renovation projects and any carpentry construction with our alfa building & alfa flooring production lines.

Complete solutions in products that can be easily combined!

Complete solutions and easily combined products

Environment

We ensure optimized supply chain management for the minimum possible impact on the environment.

Our certifications ensure our commitment to a sound environmental management system.

Aiming towards sustainability, we preserve the environment by preserving our ideals.

Our goal: **minimum environmental impact possible**



Multiple applications

We research and develop our designs, ensuring that our innovative products are always of high quality, and can be easily combined with each other, making it easier for Architects, Designers and Furniture producers to unfold their creativity. Our surfaces provide great capabilities in creating an authentic, high value aesthetic, at an affordable price, while enjoying the benefits of an easy maintenance.





Research & innovation

Implementing innovative methods of production is and will always be our focal point in achieving our goals and providing top-notch services. Modern trends are studied and through collaboration with designers and architects.

We introduce new products and styles, which should respond to a future function, use and design.

The goal is to create fully customized solutions for our partners (architects, designers and furniture producers etc) in line with modern and future trends.



Quality & reliability

We provide certified high quality materials and eco-friendly, produced in our factories with innovative technologies, while being monitored by strict quality control systems, to ensure company's high level of reliability.

Combining applications & solutions

for furniture and interior decoration

1002 Natural Oak
1000 Series
Varnish Color 400
Premium collection



2304 Basic Line
Laminate Flooring



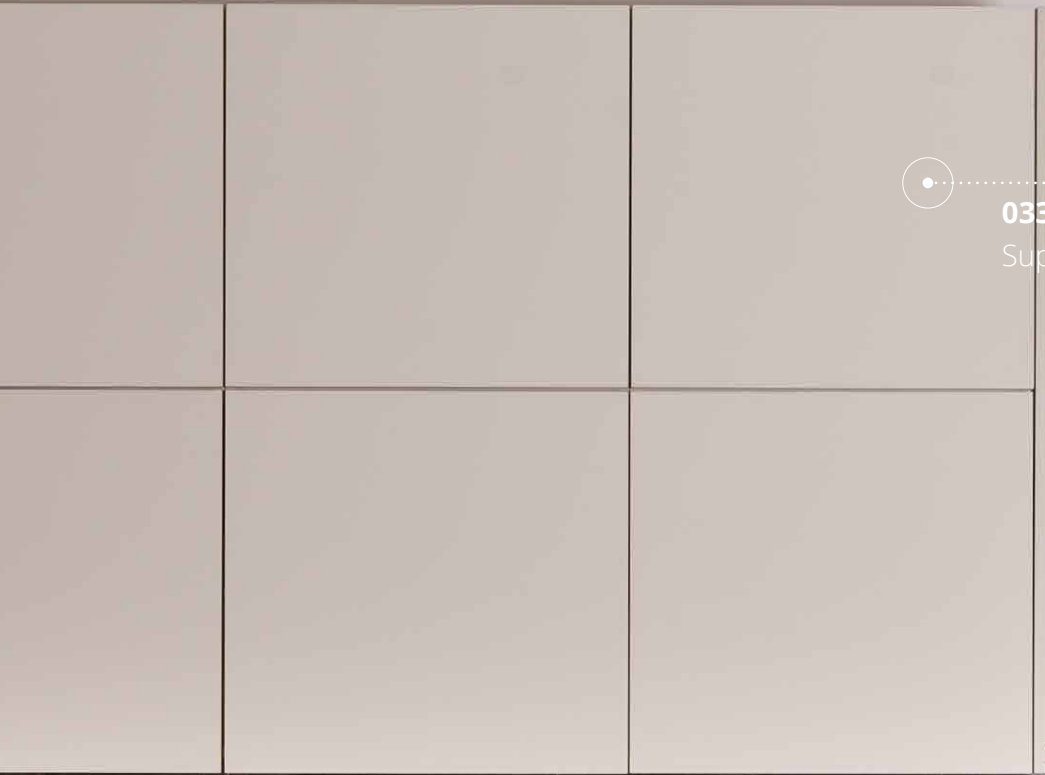

0337 Magnolia
Super Matt



F6812 Exclusive Collection
Worktop



9310 Noce Lirico
Intra | Premium

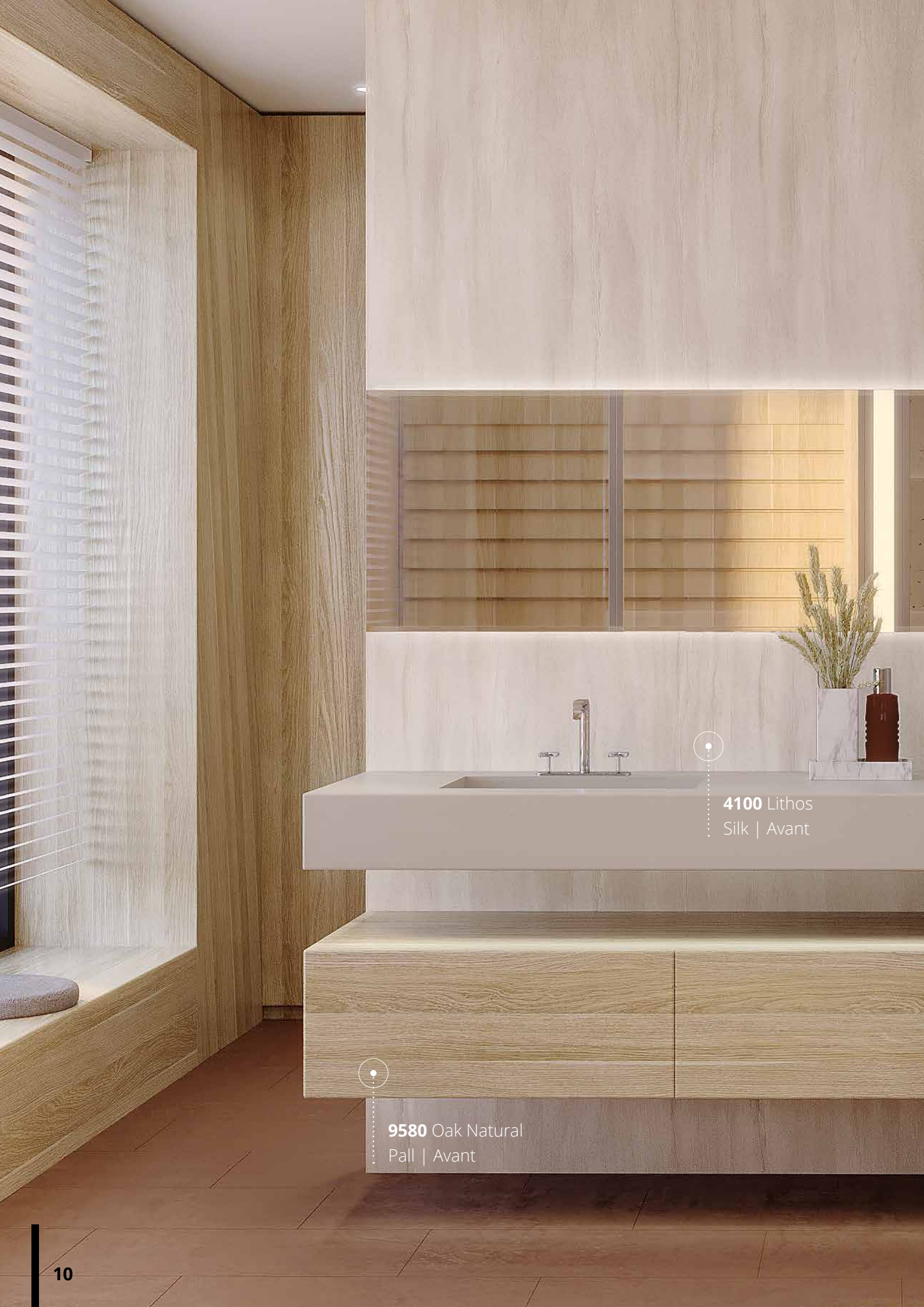

4100 Lithos
Silk | Avant



9580 Oak Natural
Pall | Avant



2011 La Villa Marble
Terra | Premium



9801 Grey Ash
Libre | Synchro

4200 Marmo
Silk | Avant

1176 Sahara
Pet Matt

9803 Natural Ash
Libre | Synchro

2011 La Villa Marble
Terra | Combo Collection

Lefkada - Veneer:
Vero - Premium Doors:

2667 Honey Rovere
Alto | Synchro



2665 Dark Brown Rovere
Alto | Synchro

Combining and matching products



We adjust our production lines, guided always by the combination and application of materials, regardless of the project's requirements. All our products can be combined with each other, giving the opportunity to architects, designers and furniture producers to express their creativity. The full range of products we have developed, provide limitless possibilities. You can choose from Alfa Panels series the right material for your application: furniture or outdoor products use. With our Alfa Surfaces® series you can choose from a wide range of surfaces to improve your constructions and create a beautifully combined interior space with furniture, panels, doors or any other construction you have designed.

Benefits

- Complete series of decorative surfaces
- Large selection of panels for multiple uses (melamine, veneer or lacquer coating)
- Combination of alfa series surfaces in different panels, with uniformity in appearance and quality
 - Our materials are eco friendly
 - The alfa surfaces series are combined perfectly with edge bandings
 - Fire retardance
 - Resistance to moisture





9310 Noce Lirico
Intra | Premium

Particle board coated with decorative melamine film (MFC)

Melamine Faced Chipboard (MFC) is the most popular material with a wide range of applications in furniture.

MFC is particle board coated with decorative surfaces of advanced technology with antibacterial & antifungal properties. Available in many colors and textures, ideal material for furniture.

Characteristics

- Flawless surface
- High stability
- Easy processing
- Easy cleaning
- Ideal cutting quality

Advantages

- Wide variety of shades and textures
- High mechanical, thermal and chemical resistance (Abrasion resistance, resistance to scratches, Cigarette burning, Heat resistance)
- Also available as moisture resistant
- Non-toxic
- Eco friendly

Formaldehyde emission class **E1**

Applications

Shop furniture, home furniture, hotel furniture, kitchen furniture, closet furniture, office furniture, interior doors, wallpapers.



● **0335** Sand
Super Matt

● **9316** Pine Brown
Intra | Premium

Fiberboard (MDF)

melamine coated

Melamine Faced MDF boards, MDF. Its core is made of wood fibers, giving a smooth surface, with high density and stability, which makes it an excellent material for processing. MDF is upholstered with decorative surfaces of advanced technology with antibacterial & antifungal properties. Available in many colors and textures. Ideal material for furniture design.

Characteristics

- Flawless surface
- High stability
- Easy processing
- Easy cleaning
- Ideal cutting quality

Advantages

- Wide variety of shades and textures
- High mechanical, thermal and chemical resistance (Abrasion resistance, resistance to scratches, Cigarette burning, Heat resistance)
- Also available as fire retardant and moisture resistant
- Non-toxic
- Eco friendly

Formaldehyde emission class **E1**



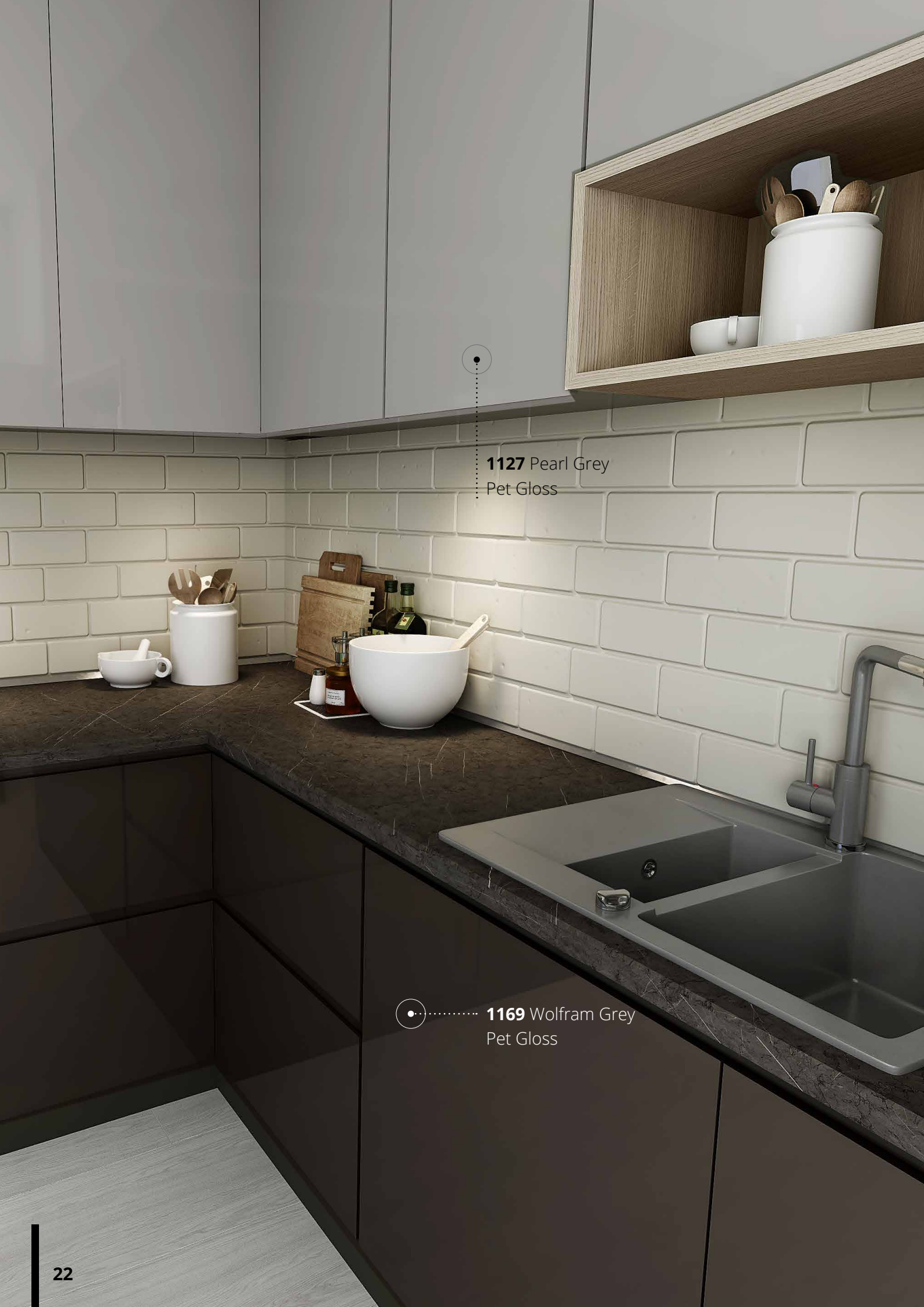

1127 Pearl Grey
Pet Gloss

1169 Wolfram Grey
Pet Gloss

Acrylic HDF panels

super gloss, super matt

pet gloss, pet matt

Acrylic HDF panels consist of a decorative soft paper film coated on HDF (High Density Fiberboard) panel, formaldehyde free with extremely high levels of gloss.

Characteristics

- Scratch resistant
- Glossy or matt
- Mirror effect
- Variety of colors
- UV resistant
- Also available as fire retardant and moisture resistant
- Combined with ABS edge bandings in the same colors
- Eco-friendly material

Formaldehyde emission class **E1**

Applications

Wall cladding, home furniture, hotel furniture, shop furniture, commercial spaces, kitchen furniture, wardrobe furniture.





F6821 Exclusive Collection
Worktop



9316 Pine Brown
Intra | Premium

Kitchen worktops

Kitchen worktops (ALFA TOPS) consist of particle board which is coated with high pressure laminate (HPL). HPL surfaces offer a reliable and durable protection against bacteria. It is high hygienic and can be cleaned very easily.

A special silicone is placed at the bottom alongside the bench, forming water drops barrier. Available in rounded U-shaped profile R & RADIO R2 at 19, 28, 38 mm.

E1

NON-CARCINOGENIC
RAW MATERIALS



ABRASION
RESISTANCE



IMPACT
RESISTANCE



ACID
RESISTANCE



EASY TO
CLEAN



DURABILITY
OVER TIME



RESISTANCE
TO MOISTURE



RESISTANCE
TO SUNLIGHT



TENSILE
STRENGTH



RESISTANCE TO
SCRATCHING



RESISTANCE TO
EXTREME TEMPERATURES



Characteristics

- Impact resistance
- Abrasion resistance
- Resistance to various types of scratches
- Antibacterial
- Color stability in light but also in artificial lighting Resistance to high and low temperatures
- Resistance to high and low temperatures
- Resistant to cleaning products
- Stain resistance
- Resistance to cigarette burning
- Strong resistance to UV rays

The raw materials used are eco friendly
Formaldehyde emission class **E1**

Specifications

HPL surface: 0.7mm

Length: 4.20m & 2.10M

Shapes & Dimensions

Single rounded: width 60 cm

Double-rounded: width 40, 64, 80, 100cm

Shapes: U

Radio: R2

Produced in raw & moisture resistant particle board (ChipBoard)
also in HDF moisture resistant (U 20mm)

APPLICATIONS

WORKTOP



U 19mm
Black Core



U 28mm



U 38mm





F6813 Exclusive Collection
Worktop

Kitchen splashbacks

Kitchen worktops are also available in splashbacks in order to complete the final outlook in kitchens, offices or workplaces.

The 10mm thick splashbacks are made of particle board and decorative laminate high pressure (HPL), perfectly matching the design of the worktop.

Formaldehyde emission class **E1**



Edge bandings

Alfa Wood Group edge bandings are designed to offer a balanced look with decorative panels and edges, forming an ideal decorative finish. Choose from our range of ABS, PVC or veneer in standard thicknesses and widths. The base material for our edge bandings is acrylonitrile butadiene styrene (ABS), a sturdy plastic material, easy to process.

The range of our edge bandings matches perfectly the color and texture of our melamines, glossy and matt products, creating an attractive and durable finish.

Characteristics

- Resistant to scratches and abrasion
- Perfectly combined with all colors and textures
- Easy processing
- Elastic and durable
- Resistant to heat and light

Formaldehyde emission class **E1**

Applications

Melamine panels edges



● **9316** Pine Brown
Intra | Premium

MDF Brushed veneer coated

Veneered fiberboard is a panel based on MDF Boards and veneer layons ,coated with brushed veneer.

We renovate the wood and process the veneers with a brushing technique. By this technique, the softest part of the wood is removed, creating a visual contrast. It is the right material for a rustic effect and a particularly elegant charm to the furniture constructions when the main design goal is individuality.

The design, elegance and natural character of a vintage decoration or product.

Characteristics

- Ideal material for polishing
- Flawless surface
- High stability
- Easy processing
- Easy cleaning
- Ideal cutting quality
- Eco-friendly material

Formaldehyde emission class **E1**

Applications

Shop furniture, home furniture, hotel furniture, kitchen furniture, furniture wardrobe, office furniture, interior doors, exterior doors, wall coverings





MDF veneer coated

MDF Veneer Faced Board is a wood-based panel, coated with layons on one or both sides with natural or artificial veneer.

Veneer is a natural product distinguished for its uniqueness and made from processed natural wood in thin layers (veneer layons) . In the production process, a strict selection of veneers is made depending on their type and quality in a specially designed air-conditioned environment, in appropriate temperatures for the relative humidity of the veneer. It is a classic material for furniture manufacturers when it comes to personalization, quality and individuality of a decoration or product. Available in a wide variety of wood species, is an ideal material for furniture.

Characteristics

- Large variety in designs and textures
- ideal material for varnish / paint
- Flawless surface
- High stability
- Easy processing
- Easy cleaning
- Ideal cutting quality
- Available in fire retardant and moisture resistant
- Eco-friendly material

Formaldehyde emission class **E1**

Applications

Shop furniture, home furniture, hotel furniture, kitchen furniture, furniture wardrobe, office furniture, interior doors, exterior doors, wall coverings





Particle board veneer coated

Veneer Faced Chipboard is a classic material for furniture producers when the main goal is personalization, elegance and individuality of a decoration or a product. Available lined with natural or artificial veneer, as well as in a wide variety of wood species, is an ideal material for furniture.

Characteristics

- Flawless surface
- High stability
- Ideal material for polishing
- Available in a wide variety of shades and textures
- Easy processing
- Eco-friendly material
- Ideal cutting quality

Formaldehyde emission class **E1**

Applications

Shop furniture, home furniture, hotel furniture, kitchen furniture, furniture wardrobe, office furniture, interior doors, exterior doors, wall coverings.





Lacquered fiberboard

Lacquered fiberboard is a thin high-density wood panel, coated with ecological colors and uniform surface.

Characteristics

- Ability to fold
- No need for (PVC)
- Produced in addition to white in a wide range of ecological one or two sided colors
- Combined perfectly with AWG melamine colors
- Eco friendly material

Formaldehyde emission class **E1**

Applications

Furniture (furniture backs and drawer bottom, drawer boxes & small furniture), interior doors





Fiberboard Moisture resistant

Moisture resistant fiberboard is a wood-based panel produced from wood fibres glued with resin, taking their final form after exposure to high-pressure conditions and temperature.

Fiberboard is particularly suitable for constructions that require panels, with high resistance to moisture but also for a wide range of indoor applications. The product can be coated with HPL, melamine, veneer or, for further processing, by painting.

Panels are being produced with green fibers in their basic form.

Characteristics

- Flawless surface texture
- Tensile strength
- High stability
- Easy processing
- High flexural strength
- High density

Advantages:

- Resistant to high humidity environment,
- Resistance to UV rays
- High stability to environmental changes
- Non-toxic
- Eco-friendly material

Applications

Furniture, Doors, Furniture
Bathroom, Work Benches, Modern
Design

Formaldehyde emission class **E1**



Fiberboard Fire retardant

Fire retardant fiberboard is a wood-based panel produced of wood fibers which are composed of three layers and glued with resin taking their final form after exposure to high conditions pressure and temperature. Fiberboard is particularly suitable for construction requiring panels with high resistance to fire but also for a wide range of internal application. The panels are manufactured in accordance to strict standards. including fire protection and in particular the possibility to delay the spread of fire.

The panels are produced with red fibers in their basic form.

The product can be coated with HPL, melamine, veneer or, for further processing, by painting.

Characteristics

- Fire retardant
- Flawless surface texture
- Tensile strength
- High stability to environmental changes
- Easy processing
- High density
- Eco-friendly material

Applications

In buildings with increased requirements for fire resistance such as public buildings, hospitals, schools, airports, doors, and cabinets.

Formaldehyde emission class **E1**



Fiberboard Alfa Solid Compact

Alfa Solid Compact is a 12mm thick fiberboard with special processing, which combines very high moisture resistance, with increased mechanical properties. It consists of wood fibers in which environmentally friendly resins are added, materials which give the extra resistance to the material.

Fully complies with V100 tests (as described in EN 1087-1). It can be produced in all colors of our decorative surfaces (melamine). The backface of the Alfa Solid compact is solid colored.

Applications: The new product has many applications:

Alfa Solid Compact fiberboard is an excellent material and is available with a black core for surfaces which require high durability and resistance, in order to show increased resistance to hard treatment and climate change.

All layers are compressed at high pressures and temperatures. The Alfa Solid Compact can be coated with HPL or melamine. The Alfa Solid Compact meets the V100 tests (as described in EN 1087-1) standards.

Characteristics

- Black color core
- Smooth surface
- Abrasion resistant
- High flexural strength
- High tensile strength
- Alfa Solid compact backface is solid color
- Resistant to environment with high requirements of high humidity
- Resistance to UV rays
- High stability to external condition changes
- Available in fire retardant and moisture resistant material

Advantages

- Can be combined with all AWG decorative surfaces

Formaldehyde emission class **E1**

Applications

Hotel rooms, commercial spaces, wall cladding, benches work and kitchen, cabins, partitions, table tops, health care facilities, indoors with high humidity, space divider with high temperatures changes, in external spaces as a coated product, on exterior doors, lofts, kitchen worktops. Used in areas with high demand of fire protection, airports, hospitals, hotels, commercial stores.



Fiberboard L.A.F.

Low Added Formaldehyde product

L.A.F. is a fiberboard that combines very high humidity resistance, with enhanced mechanical properties without the addition of formaldehyde. Consists of wood fibers glued by environmentally friendly resins.

Fully complies with V100 tests (as described in EN 1087-1).

Characteristics

- Resistance to moisture
- Flawless surface texture
- Very high tensile strength
- Very high stability in environmental changes
- Easy processing
- High density
- Produced in black color

Advantages

- Resistance to moisture
- Resistance to UV rays
- Non-toxic
- Eco-friendly material

Applications

High humidity Indoor use, for separation of areas with temperature changes, outdoors as a coated product, on exterior doors, as a material in attics, on upholstered tables exposed to external environmental conditions, etc.

Formaldehyde emission class 

Door's kit

Characteristics

Alfa Wood Group in addition to door profiles is able to provide door panels with CPL or veneer. Door profiles are the key element in the construction of prefabricated door kits. The profiles are produced in plywood, which is coated with CPL or natural veneers. The gluing process ensures an excellent adhesion to the substrate.

Profile dimensions are: 10mm, 13mm, 15mm, while the length is 2.250mm. Doors are produced with internal honeycomb paper while the perimeter of the frame is made of wood, which guarantees long-term stability. Door panels can be externally lined with over 30 decorative surfaces pre-sented in our catalog. The panels can also be coated with natural veneers.

The doors kit includes:

- Frame produced of blockboard, 44mm thickness
- frame shape is Grande Cantone (square)
- door structure is made of solid wood laminate
- Solid wood frame 8cm
- "Honeycomb" sound-absorbing cell
- 6 mm fiberboard panel coated with CPL or VENEER
- Soundproof hinges

Dimensions:

- Width: 63,3 cm – 68,3 cm – 73,3 cm – 78,3 cm – 83,3 cm – 88,3 cm – 93,3 cm – 98,3 cm
- Height: 217cm maximum

Optional Equipment:

- Glass frame
- Dashboard frame
- Aluminum rod
- Fill with sound insulation panel (28db)
- Embossed designs

Advantages:

- Available in stock colors, immediate shipment
- Perfect compatibility between panel, frame and edge banding.
- Ability to create "custom dimensions"
- Quality guarantee for all materials that make up a door

Formaldehyde emission class **E1**

Technical Details

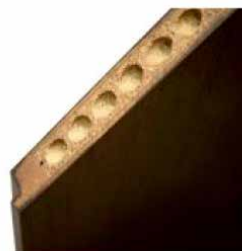
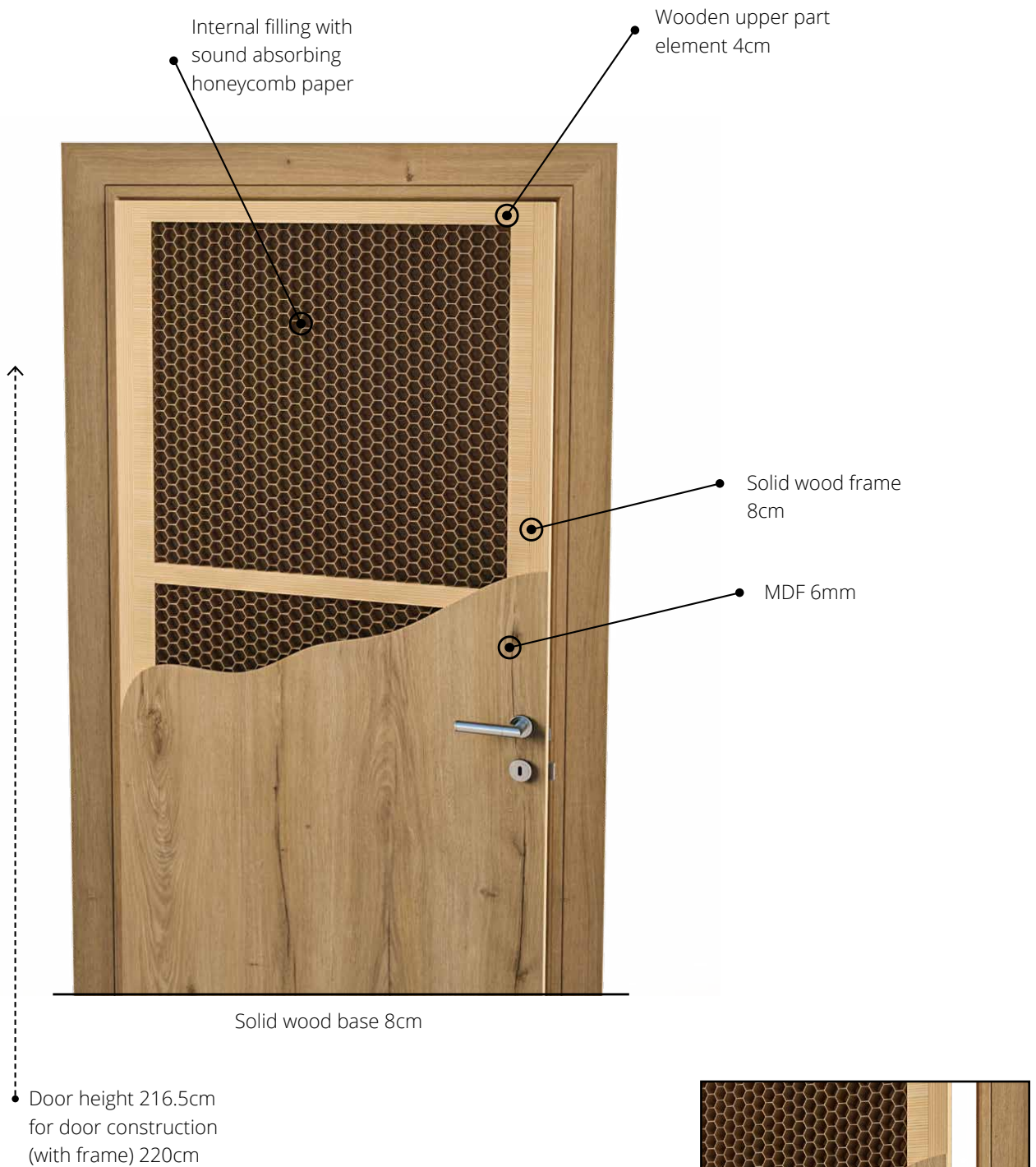



2021 Elegant Line
Laminate Flooring

Laminate flooring

ALFA WOOD group's Master Laminate floors are the only Greek flooring products.

The 27 colors (9 Basic Line in thickness 7mm AC3, 4 Classic Line in thickness 8mm AC5-4V and 14 Elegance Line in thickness 8mm AC5-4V) capture in the most realistic way all natural features of a real wooden floor

The most important advantages of Master Laminate:

- **Durable:** furniture or other heavy objects load bearing, cigarette burning, sharp objects (pointed heels)
- **Light:** laminate floors are resistant to UV rays and do not discolor.
- **Eco-friendly:** produced of 90% wood, which comes from sustainable forestry practices
- **Anti-allergic**
- **Long lasting:** lasts 15 to 30 years
- **Perfect appearance:** ideal imitation of natural wood
- **Installation:** easy installation as it fastens with a **uniclic** system
- Easy dismantling and repositioning 2-3 times
- Worn board **replacement** possibility
- Ideal solution for **renovations** renovations due to their small thickness
- **Anti-slip**

Formaldehyde emission class **E1**



try our new

ALFA Room
Visualizer



www.alfawood.gr/room-visualizer

American Walnut
Alfa Sonic | Acoustic Panel

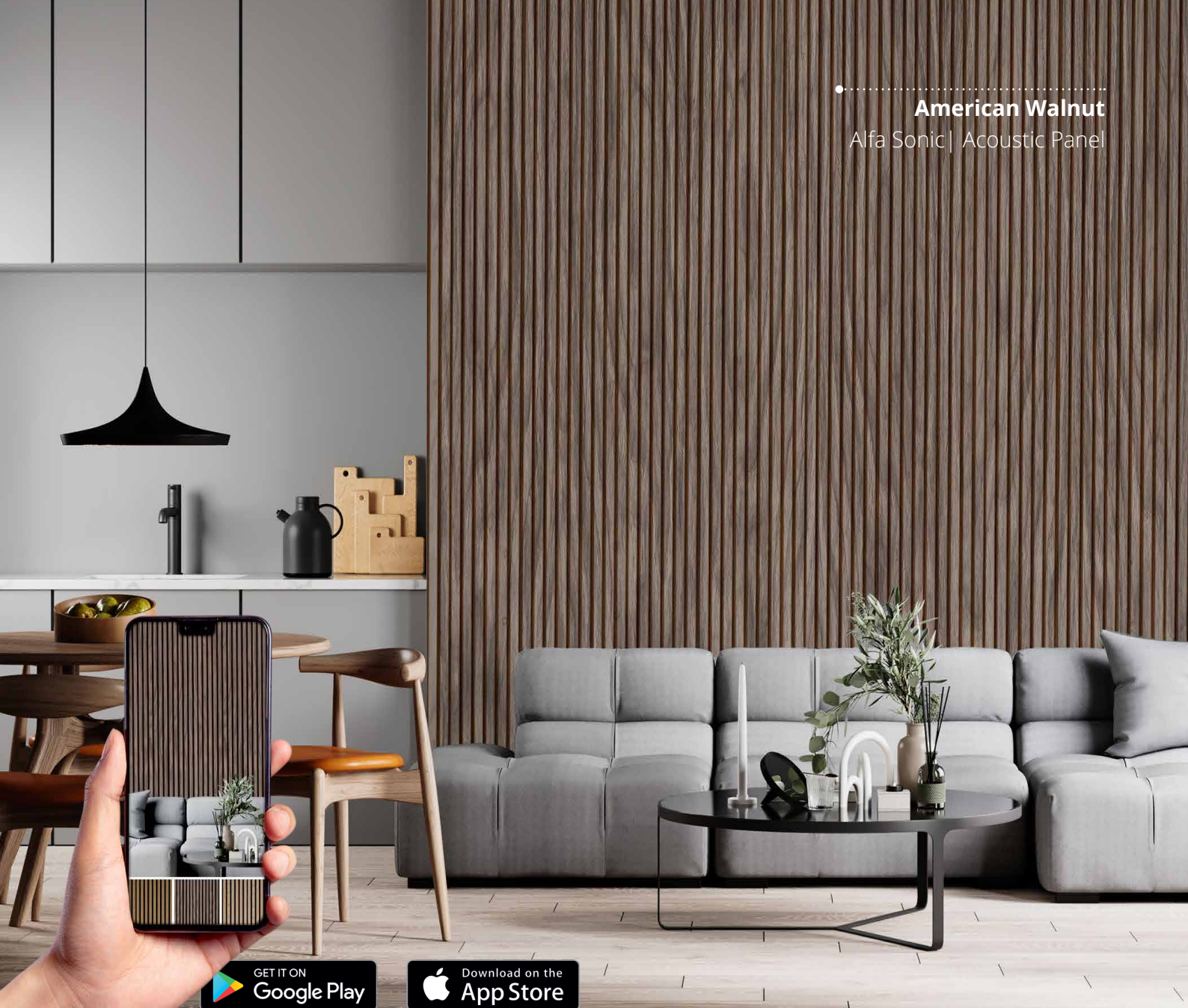

GET IT ON
Google Play

Download on the
App Store



Acoustic Panel

Linear acoustic panels based on veneered MDF slats 10mm, mounted on black polyester panels 12mm.

ALFA WOOD GROUP Acoustic panels are sound absorbing panels placed on walls or ceilings to control and reduce noise, eliminate slap echo and control comb filtering in a room. The main purpose of acoustic panels is to reduce, but not entirely eliminate, resonance within the room. Sound absorption is different than soundproofing, which is typically used to keep sound from escaping a room.

Acoustic Panels are used to treat recording studio acoustics, night clubs, church acoustics, theater acoustics, restaurant etc

Advantages:

- Available in stock colors, immediate shipment
- Ability to create "custom dimensions"
- Help control reverberation in room
- Stylish Look: Elegance and warmth
- Perfect appearance: natural wood
- Installation: easy installation

Dimensions:

22 x 2400 x 600 mm

Other sizes & features available upon request

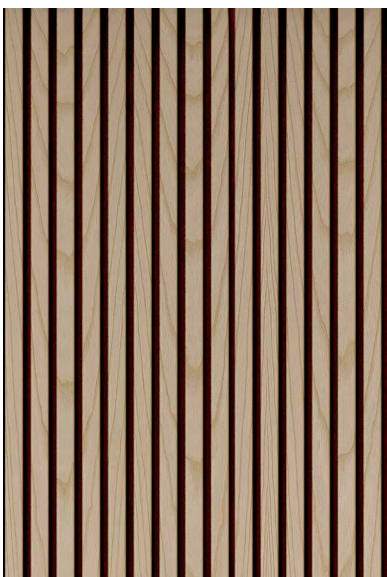

Ash | Alfa Sonic

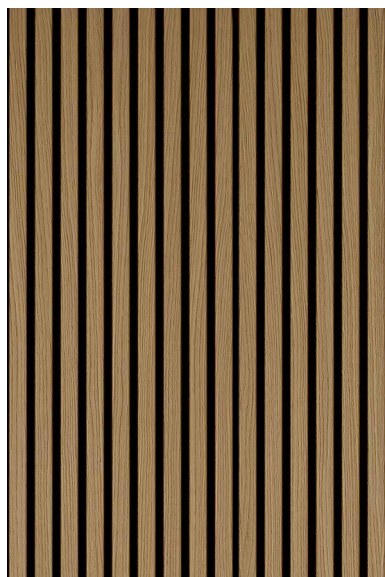

Oak | Alfa Sonic



American Walnut | Alfa Sonic



9310 Noce Lirico
Intra | Premium

9323 Elm Dark
Square



0494 | Lapis - Square



0694 | Cement - Square



0074 | Graphite - Square

Wall Cladding Square Profile

The Wall Cladding investment by Alfa Wood Group represents a suitable choice for enhancing, renewing, and creating an exceptional aesthetic outcome in both residential and commercial spaces.

This is a new product composed of MDF coated with CPL, available in various wood shades and monochromatic options.

The Wall Cladding in wood shades provides a natural appearance with textured surfaces that are ideal for wall, ceiling, furniture and even entire rooms, while the monochromatic options evoke a modern decorative style.

Wall Claddings constitute a flexible and attractive solution for interior design that can transform any room into a warm and welcoming space. It is a classic space renovation solution that exudes an atmosphere of luxury and a romantic touch while also aligning with the contemporary demands of architectural culture and lifestyle.

Advantages:

- Offers flexibility and quick installation.
- Represents a cost-effective option for renovating your space.
- Is durable.
- Easy to maintain.
- Can be customized to suit any decorating style.
- By choosing Igrafan, you can emphasize the wood finish and dare to paint these claddings in interesting shades to create a unique look that complements the space perfectly.



Dimensions:

Profile No 81 3000 x 90 x 18mm

Profile No 82 3000 x 43 x 18mm



9322 | Elm Bright – Square



9323 | Elm Dark – Square



9310 | Noce Lirico – Square

Wall Cladding

Profile No 95 & No 96

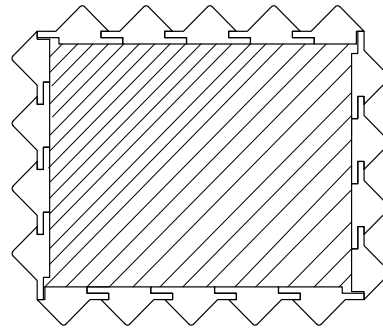

Profile No 97 & No 98

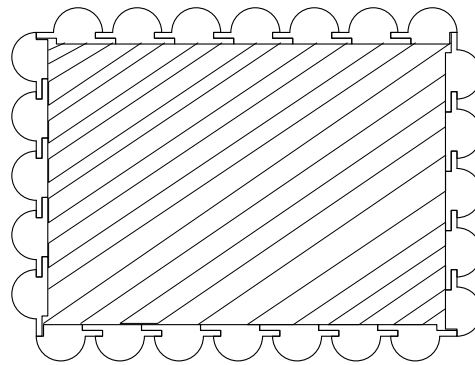

Profile No 99 & No 100

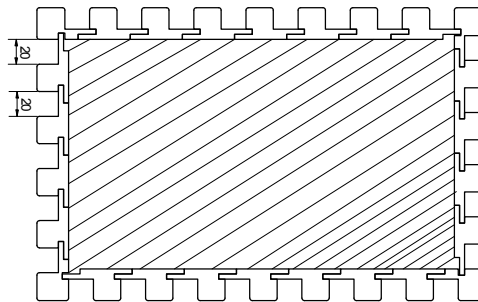

Profile No 84 & 85

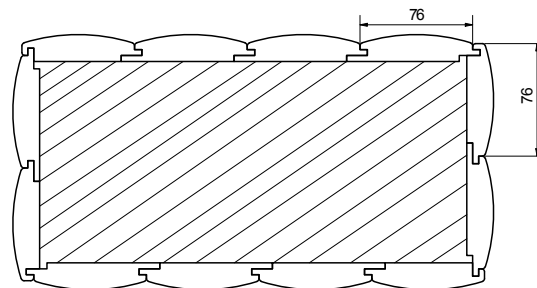

Profile No 93 & 94

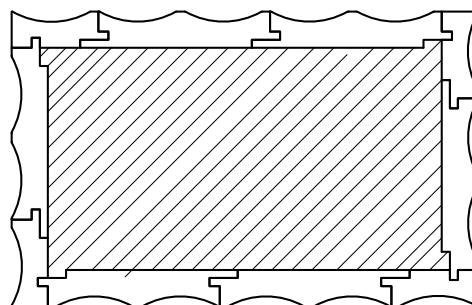



9310 Noce Lirico
Square | Wall Cladding



2010 Bianco Marmo
Terra | Premium



9323 Elm Dark
Intra | Premium



3010 Tawny Rays
Rada | Premium



Textures

The textures help us express, give character and can add a sense of realism. They allow you of high aesthetic creations by adding value in your final product, making sure it has a natural look and feel.

Discover the large selection of authentic textures that we have carefully selected to complete our range.

Synchro

A new revolutionary decorative panel. The advanced EIR technology (Embossed in Register), gives the surface an authentic look and feel of natural wood, as the texture follows the grain of the wood surface.

Synchro can simultaneously reproduce the appearance and touch, presenting an image of solid wood. The surface with clean pores and different glossy levels creates a warm and creative result.

Synchro consists of 2 textures: Alto Rovere and Libre Ash.

Alto Rovere

Libre Ash

Pall

The Pall texture features a finish that not only appears elegant and luxurious but is truly exceptional to the touch. It embodies a timeless wood texture with depth. It is an embossed surface, simulating veneer with a rugged texture and subtle recesses. The designs and colors available in the Pall surface range from wood tones to solid colors. Its matte character lends an authentic feel to different wood types.

Back side: Pall

Nava

The Nava texture is characterized by intersecting lines of bold and tasteful style, creating a rhythmic repetition of the pattern. The design of the Nava surface captivates with its alternating matte and glossy canvas.

Back side: Shagreen

Silk

The Silk texture provides a gentle velvety touch. Its processing makes it extremely suitable for modern home design, which is complemented by its «warm» surface. It is characterized by a «restrained» glossiness and an aesthetic style that functions exceptionally well. In addition to the solid colors, it is also available in marble imitations.

Back side: Shagreen

Intra

Intra is a must-have surface, which is characterized by wood's aesthetic, in all its simplicity. The design and the engraving techniques used in this finish, give the surface a unique touch, which is appreciated especially by those who love the authentic atmosphere that wood composes.

Back side: Intra

Rada

Rada surface has been awarded by the Interzum Council. It is a truly unique texture, with a realistic metallic surface effect, thanks to its mat/gloss innovative design.

Back side: Rada

Terra

Terra finish is considered one of the first innovative texture related to the concrete trend that is getting very popular in the market. The whole design is sketched by hand, with fined details that give the texture a dry effect and a stunning gritty touch. These special features are enhanced by One Technology, which makes this brand new finish one of the most fashionable and attractive ones.

Back side: Terra



Smooth

Smooth surface with low level gloss effect, suitable for combination with solid colors and high quality wooden decorations

Back side: Smooth

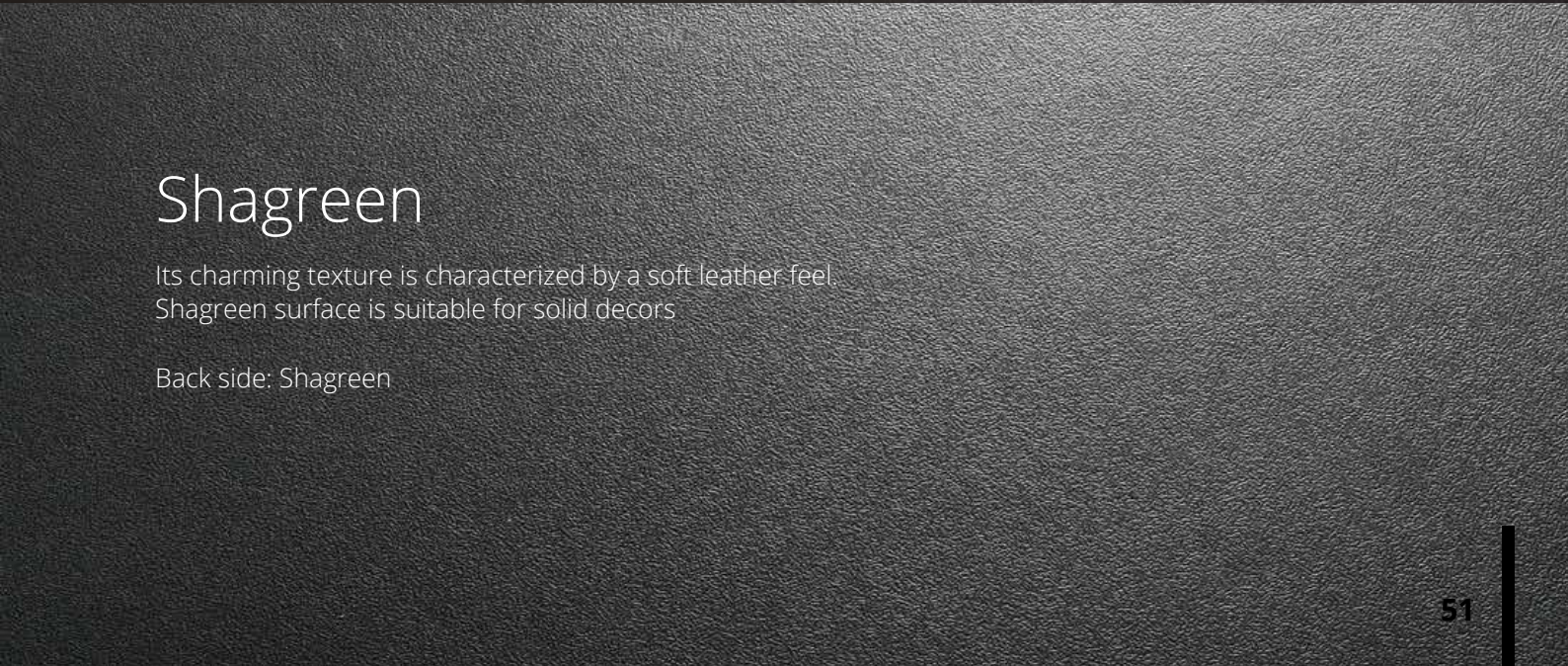

Shagreen

Its charming texture is characterized by a soft leather feel. Shagreen surface is suitable for solid decors

Back side: Shagreen

Jean

Jean surface is characterized by irregular intersecting lines that «knit» the jean surface.

Back side: Shagreen

Matrix

Matt and glossy horizontal surface lines. Matrix gives a very natural look.

Back side: Matrix or Shagreen

Wood pore

A simple and elegant texture of wood pores, which can be combined with classic wood decorative papers.

Back side: Wood pore

Soft

The soft surface gives an almost matt result. Suitable for solid colors.

Back side: Soft

Scavato

The Scavato texture is the result of a sophisticated research and development, as well as a craft and industrial vision that focuses both in detail and in technological changes.

Back side: Scavato or Shagreen

Sawn cut

The transverse texture adds depth to the surface, reproducing a rough wood feeling.

Back side: Sawn cut or Shagreen



ALFASURFACES

Melamine Faced Boards

Melamine decorative surfaces, is part of the Alfa Surfaces series. Alfa Surfaces decorative collection has been expanded to cover a wide range of applications and styles. Providing more options and applications, offering ideal solutions to architects, designers and woodworkers.

Synchro Collection

Redefines surfaces with an unparalleled authenticity that mimics the natural wood grain.

In perfect synchrony, it replicates the visual and tactile essence of solid wood, crafting a warm and artistically radiant finish with smooth pores and varying levels of gloss.



9806 Light Grey Rovere - Libre | Synchro

SYNCHRO



2663 Light Grey Rovere - Alto | Synchro



2668 Beige Rovere - Alto | Synchro



9807 Beige Ash - Libre | Synchro



2666 Natural Rovere - Alto | Synchro

SYNCHRO



9803 Natural Ash - Libre | Synchro



2669 Sand Rovere - Alto | Synchro



2664 Grey Brown Rovere - Alto | Synchro



2665 Dark Brown Rovere - Alto | Synchro



2667 Honey Rovere- Alto | Synchro



2664 Grey Brown Rovere - Alto | Synchro



9805 Light Grey Rovere - Libre | Synchro



9801 Grey Ash - Libre | Synchro



Wood

A classic choice of wood imitation textures for a warm ambience. Large selection of designs and shades, with excellent imitation of natural solid wood, provide a beautiful aesthetic result.



WOOD

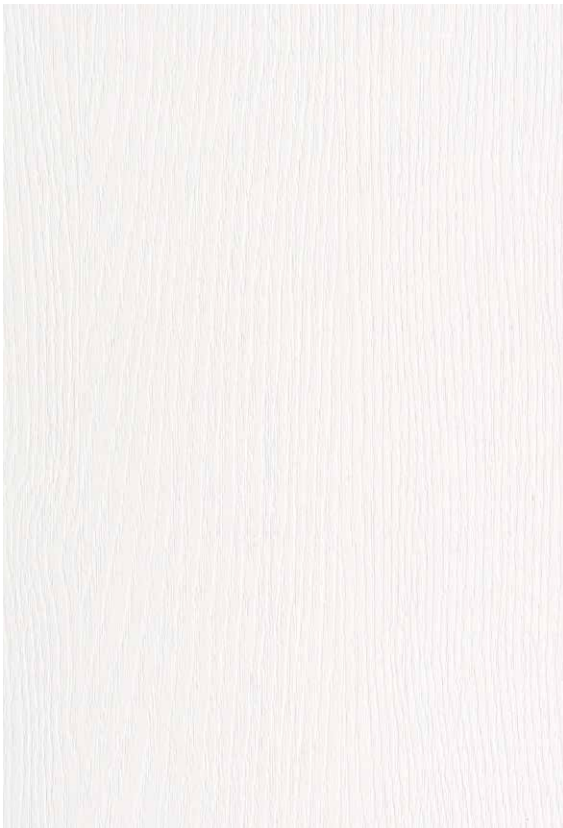

0090 White - Intra | Premium

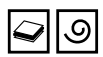

0090 White - Pall | Avant



2902 Oak Horizontal White - Matrix | Natural



0409 White Raggio - Scavato | Natural

WOOD



8902 Ice Oak - Scavato | Natural



0988 Sabbia - Intra | Premium



9322 Elm Bright - Intra | Premium



9580 Oak Natural - Pall | Avant



0988 Sabbia - Pall | Avant



9550 Castania Natural - Pall | Avant



4802 Rovere Rock - Sawncut | Natural



9303 Anziano Natural - Intra | Premium

WOOD



9202 Ice Oak Natural - Scavato | Natural



8502 Elvezia Rovere - Scavato | Natural



9570 Strada Oak - Pall | Avant



2080 Marmo Nero
Terra | Premium

9510 Fine Noce Dark
Pall | Avant

WOOD



9317 Canyon Greyish - Intra | Premium



8802 Old Wood - Scavato | Natural



8302 Elvezia Grey - Scavato | Natural



8002 Noce Beige - Scavato | Natural



0494 Lapis - Intra | Premium



0494 Lapis - Pall | Avant



9324 Amber Grey - Intra | Premium



0694 Cement - Intra | Premium

WOOD



0694 Cement - Pall | Avant



4002 Rovere Grigio - Intra | Premium



8402 Elevezia Dark Grey - Scavato | Natural



3802 Frassino Miele - Intra | Premium



9319 Pine Beige - Intra | Premium



5302 Coibra Ash Light - Scavato | Natural



0201 Pine Riga - Intra | Premium



9316 Pine Brown - Intra | Premium

WOOD



0503 Light Oak Rustic - Sawcut | Natural



7102 Energy Pine Beige Scavato | Natural



8602 Brooklyn Grey - Scavato | Natural



7202 Hick Soft - Soft | Natural



9510 Fine Noce Dark - Pall | Avant



9500 Fine Noce Dark - Pall | Avant

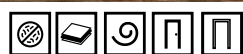

3002 Oak Horizontal Grey - Matrix | Natural



9302 Anziano Grey - Intra | Premium

WOOD



5202 Coibra Ash Dark - Scavato | Natural



0074 Graphite - Pall | Avant



9310 Noce Lirico - Intra | Premium



9323 Elm Dark - Intra | Premium



9560 Castania Grey - Pall | Avant



0074 Graphite - Intra | Premium



8702 Brooklyn Brown - Scavato | Natural



9581 Oak Brown- Pall | Avant

WOOD



8202 Noce Dark Brown - Scavato | Natural



9305 Anziano Dark Brown - Intra | Premium



3501 Winchester Walnut - Sawncut | Natural

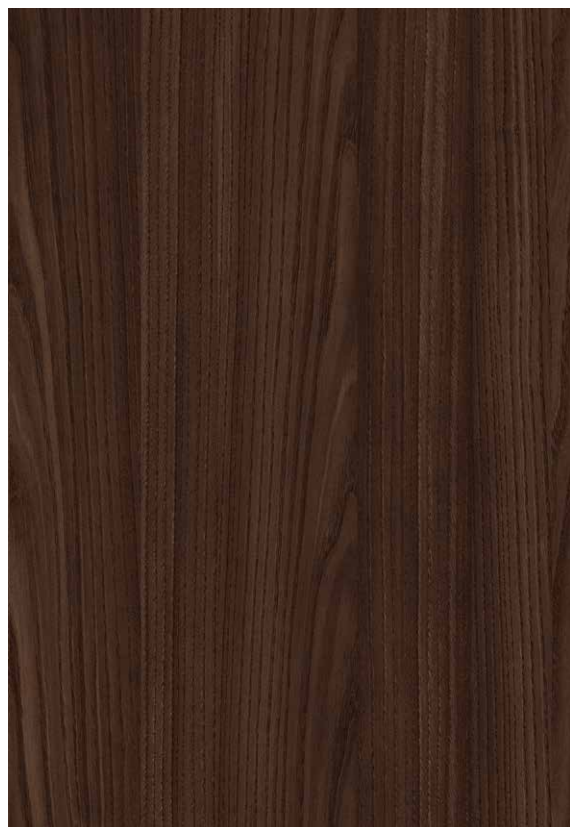

9520 Castania Dark - Pall | Avant



0070 Black - Intra | Premium

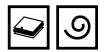
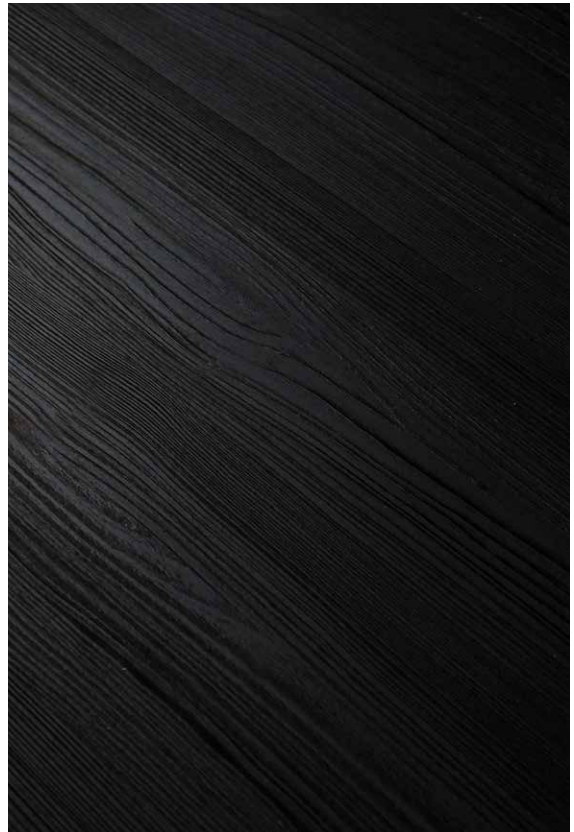

0070 Black - Pall | Avant

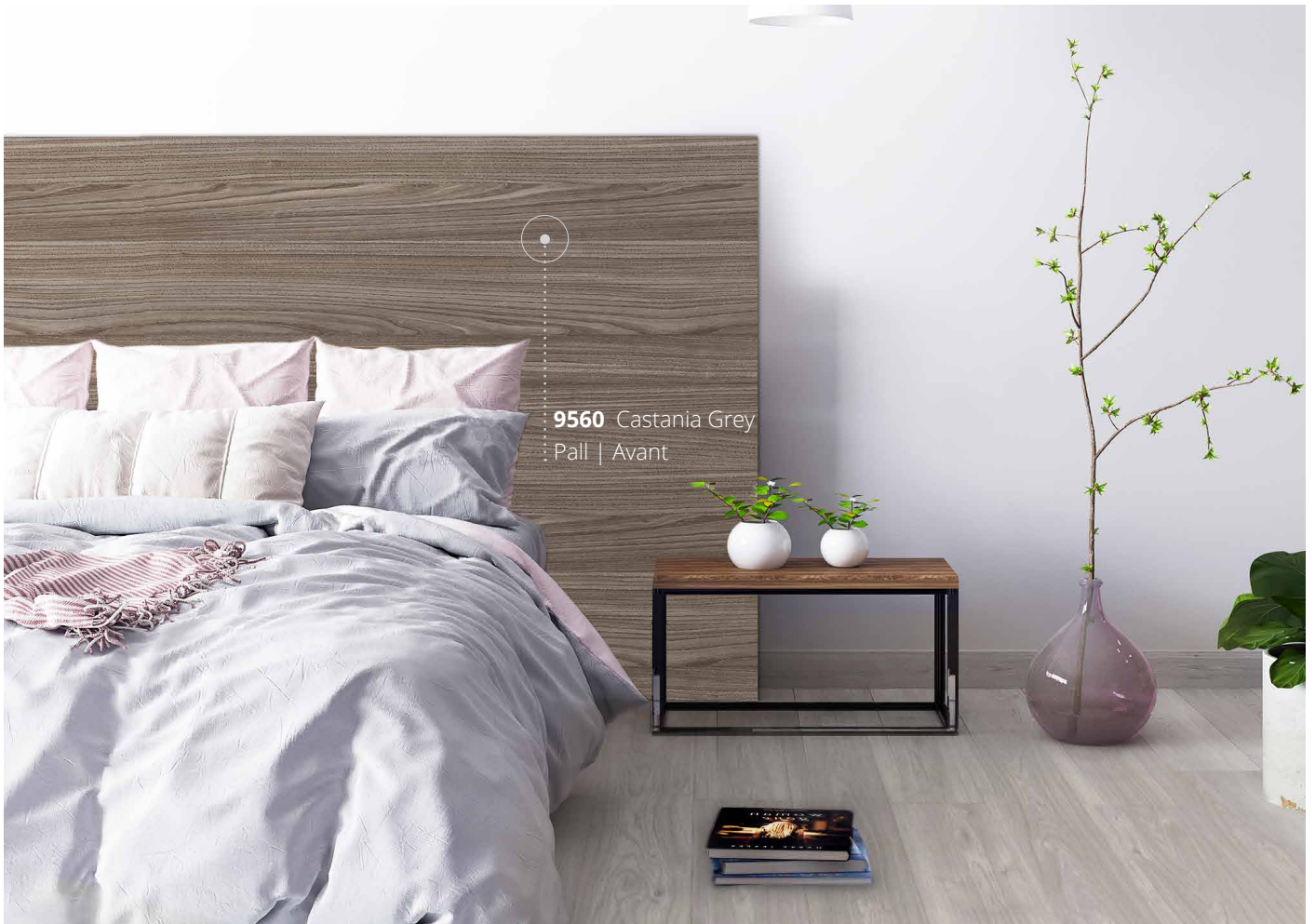

9560 Castania Grey
Pall | Avant

Solid colors

Discreet configuration of space with matt and gloss colors reproduce soft shades that are perfectly balanced and express originality.



SOLID

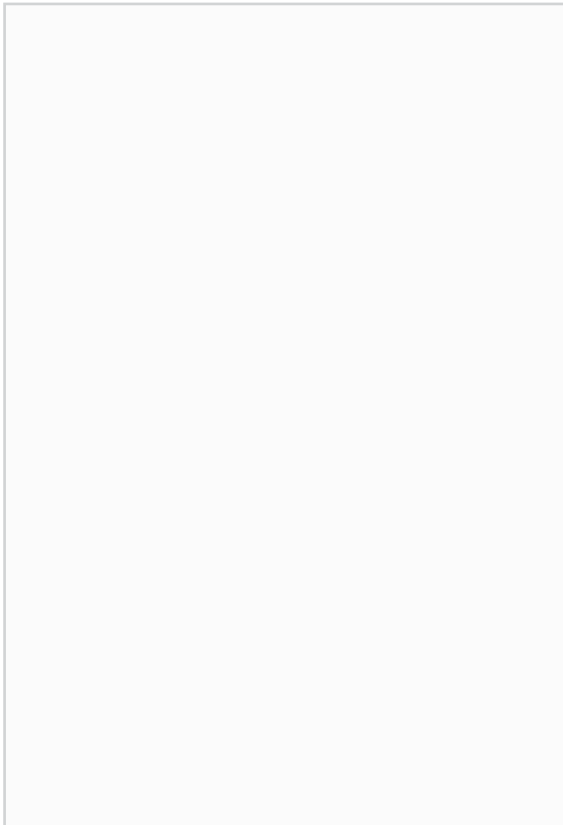

0190 Bright White - Soft | Solid

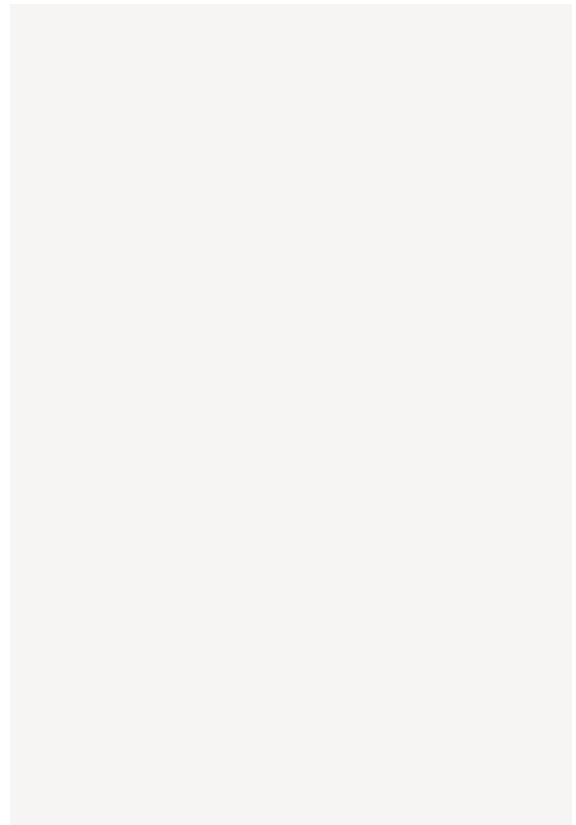

0090 White - Soft | Solid

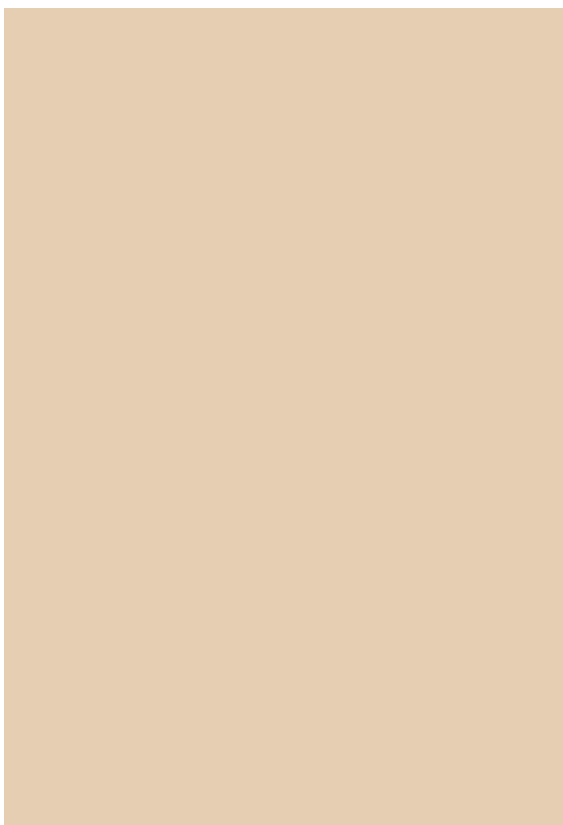

0788 Beige - Shagreen | Solid

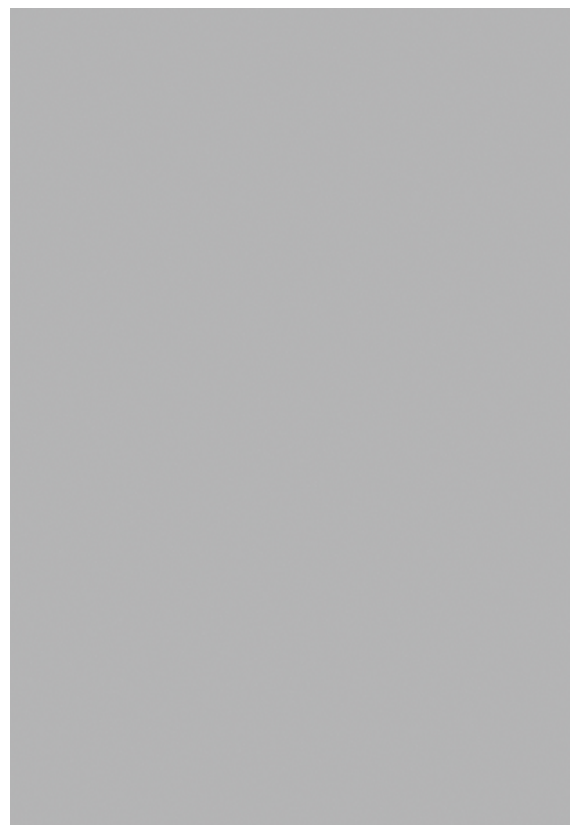

0294 Grey - Shagreen | Solid

SOLID

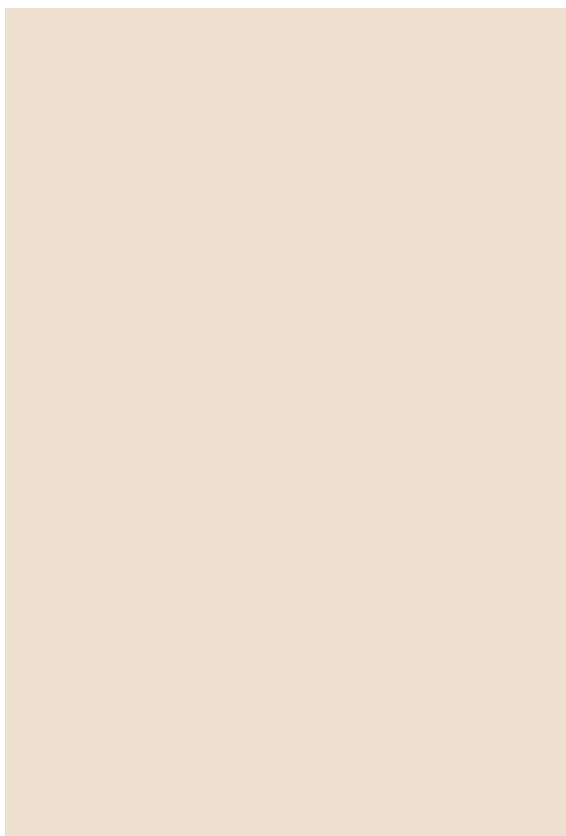

0988 Sabbia - Soft | Solid

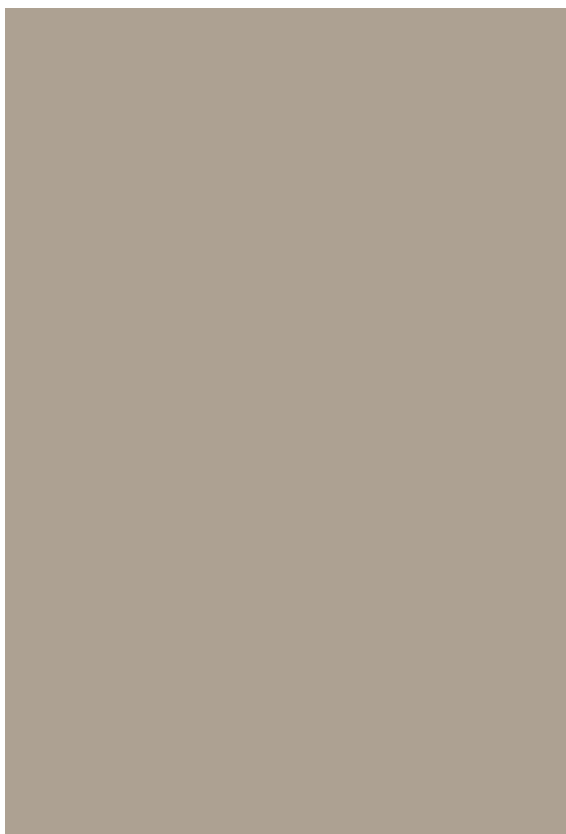

0494 Lapis - Soft | Solid



0494 Lapis - Soft |
Solid



0988 Sabbia -
Soft | Solid



0093 Aluminium - Shagreen | Solid

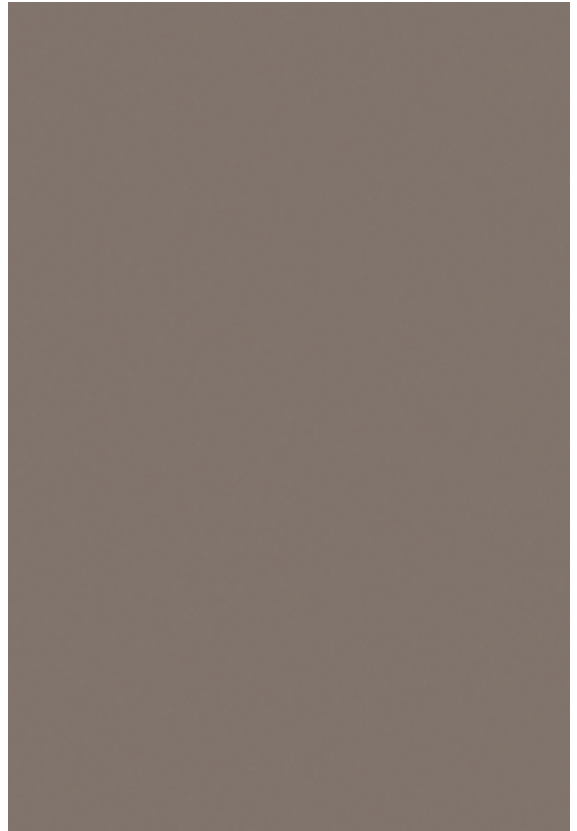

0694 Cement - Soft | Solid

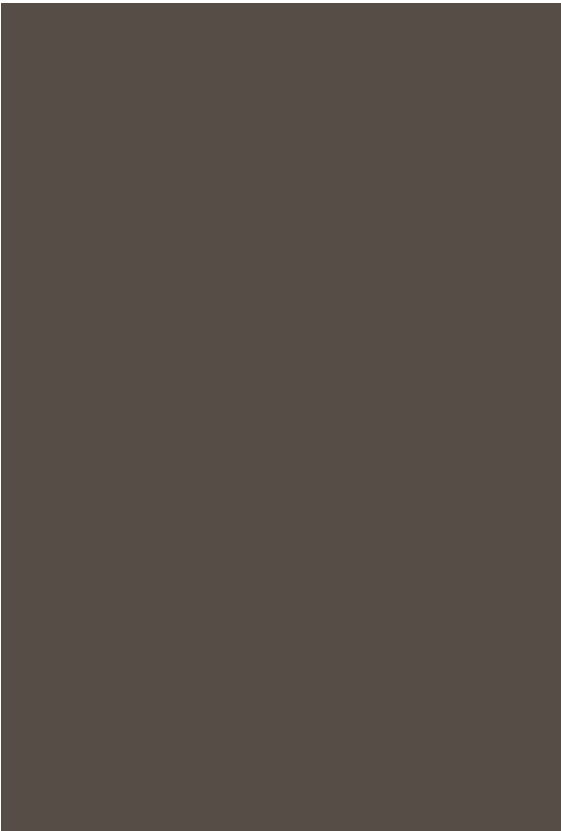

0074 Graphite - Shagreen | Solid

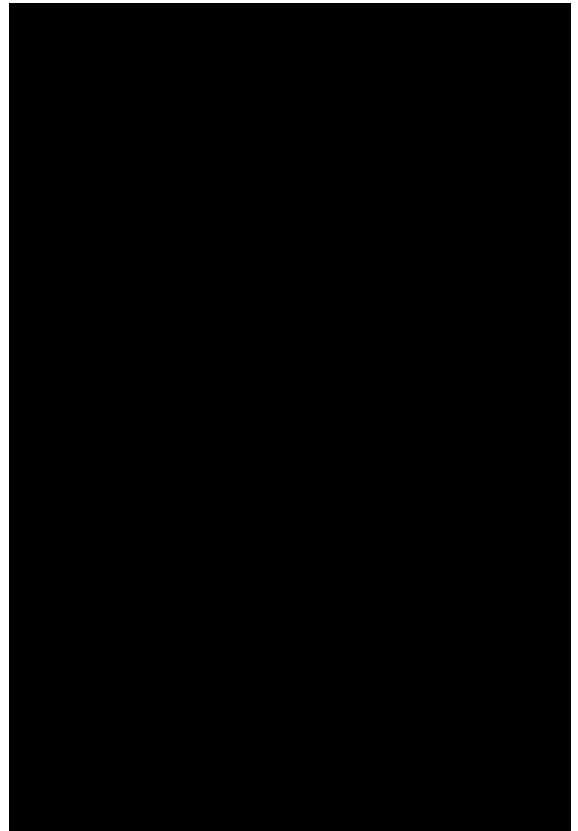

0070 Black - Shagreen | Solid

Silk

Jean surface is characterized by irregular intersecting lines that «knit» the jean surface.

The shades available make them suitable for both furniture and furniture interiors.



SILK

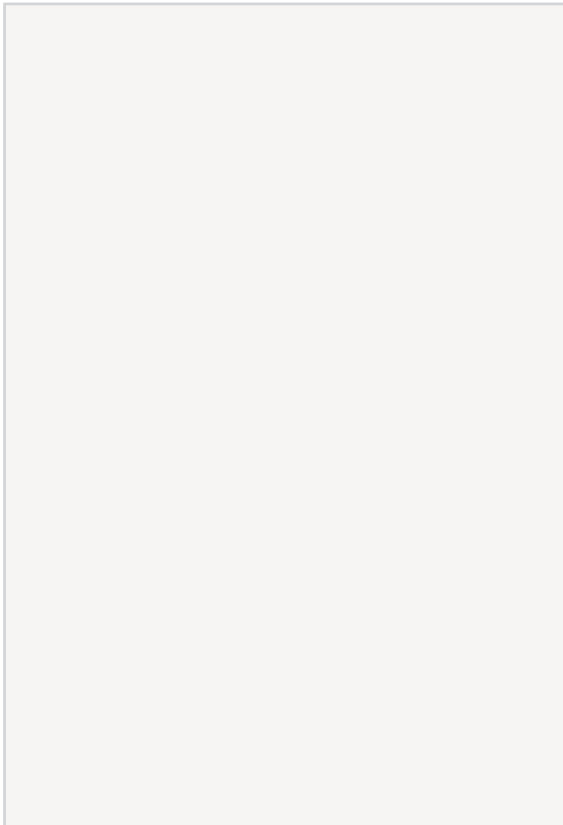

0090 White - Silk | Avant



4200 Pure Marmo - Silk | Avant



4100 Lithos - Silk | Avant

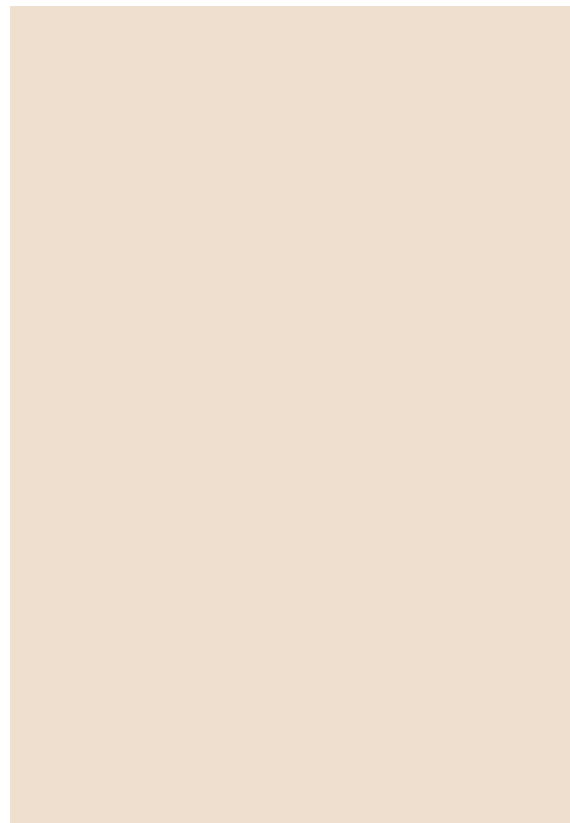

0988 Sabbia - Silk | Avant

TEXTILE



4300 Pietra Light - Silk | Avant

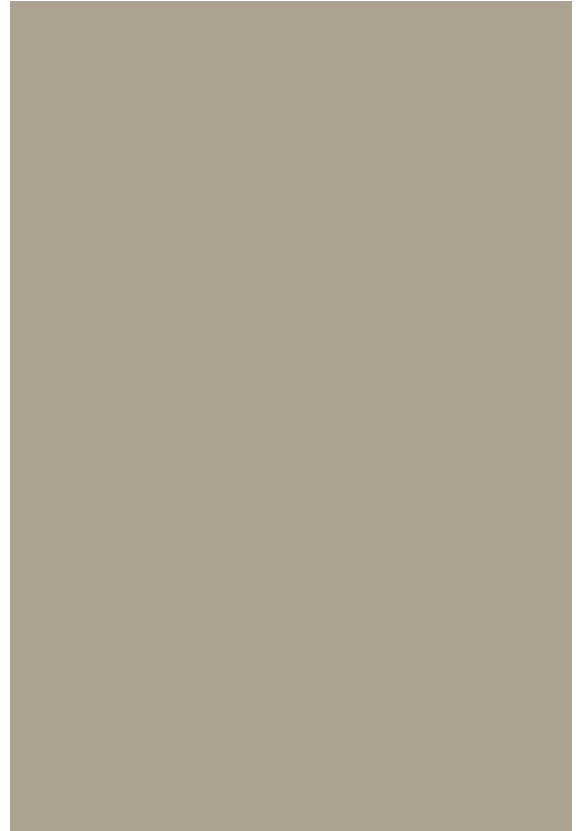

0494 Lapis - Silk | Avant

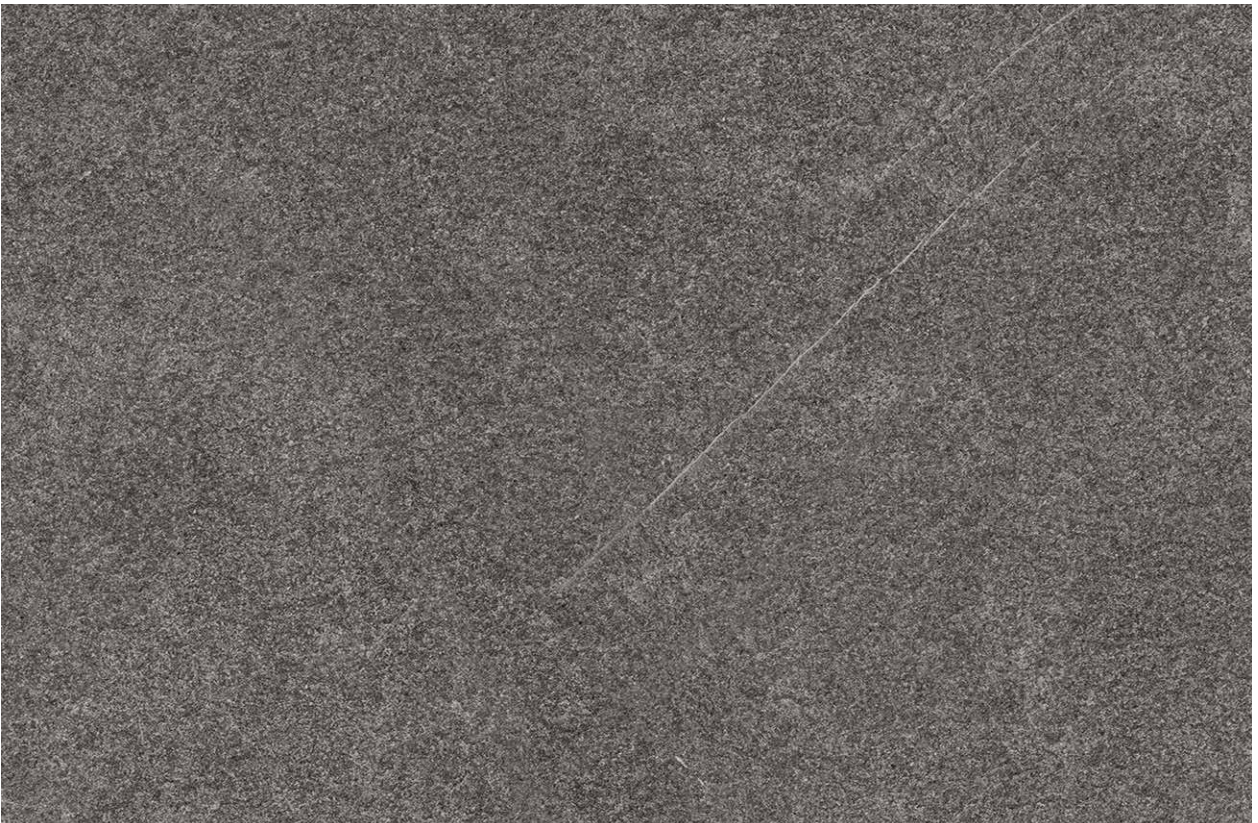

4500 Pietra Grey - Silk | Avant

SILK



0694 Cement - Silk | Avant



0074 Graphite - Silk | Avant

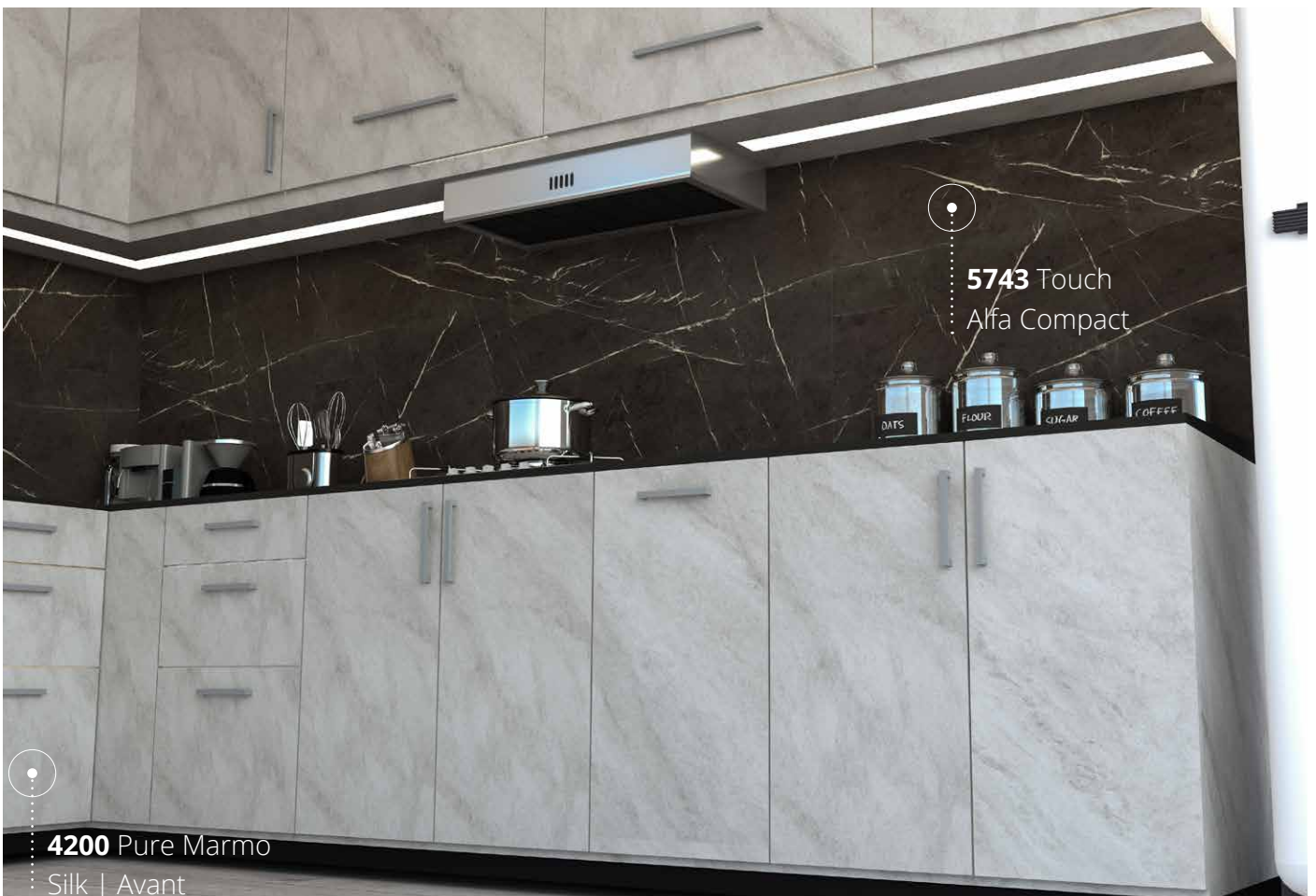



Jean

Jean surface is characterized by irregular intersecting lines that «knit» the jean surface.

The shades available make them suitable for both furniture and furniture interiors.

JEAN / TEXTILE



0190 White - Jean Surface

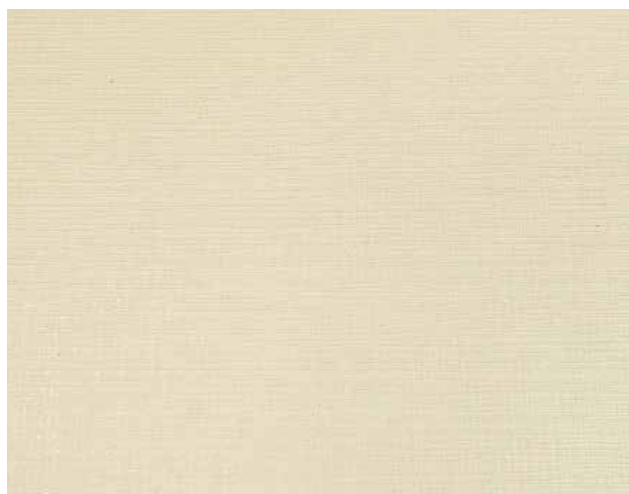

0988 Beige - Jean Surface



0308 Liniero - Jean Surface

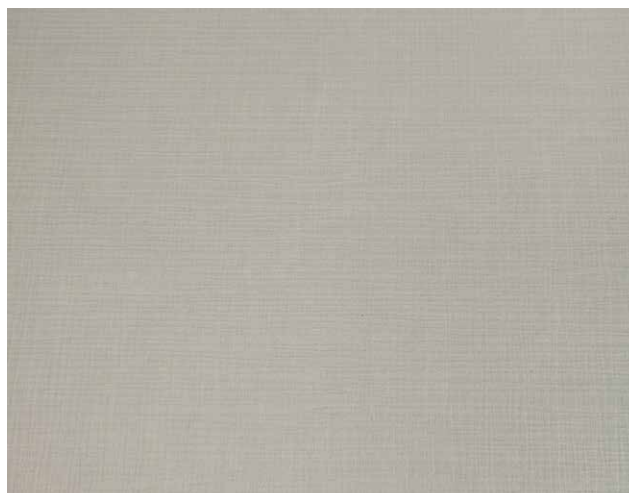

0294 Grey - Jean Surface



0608 Liniero Grey - Jean Surface

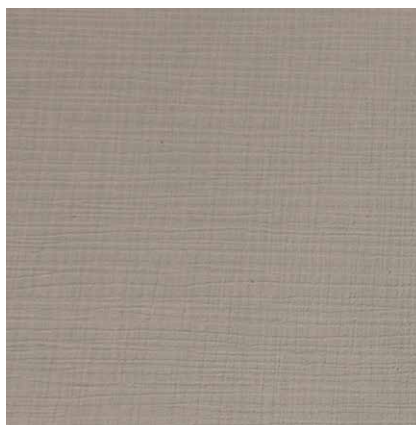

0494 Lapis - Jean Surface



0694 Cement - Jean Surface

Textile

Unique aesthetics for your space, combined fabric imitation textures, so you can have a perfect visual end result.

TEXTILE

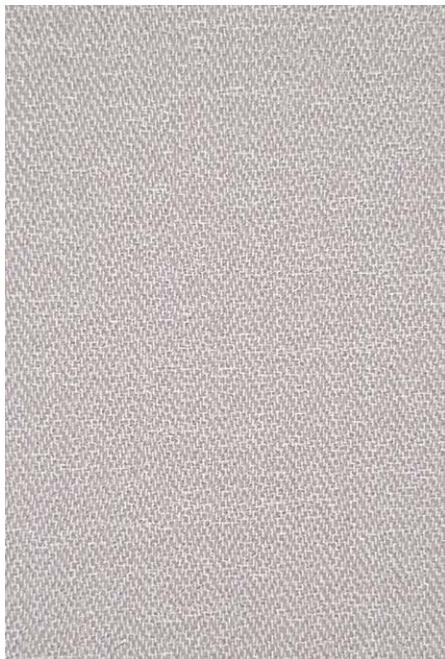

1094 Fishbone Beige - Scavato
Textile



0308 Liniero - Shagreen
Textile



0894 Textile Grey - Shagreen
Textile



0608 Liniero Grey - Shagreen | Textile

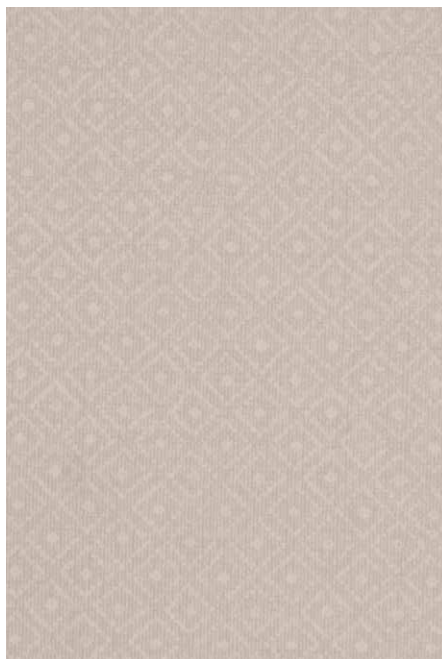

1095 Reef Beige - Soft | Textile

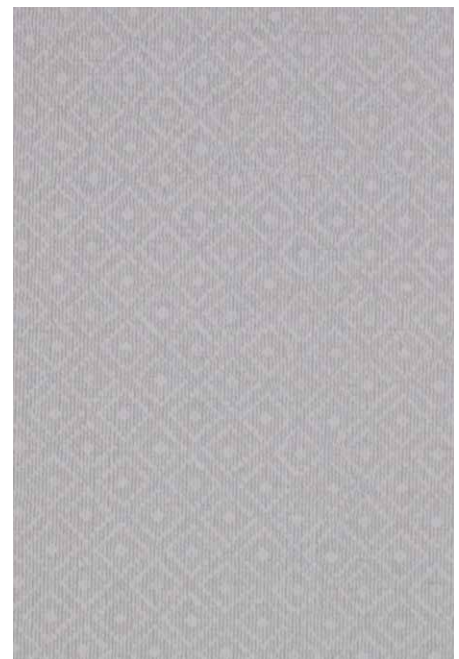

1096 Reef Grey - Soft | Textile

TEXTILE

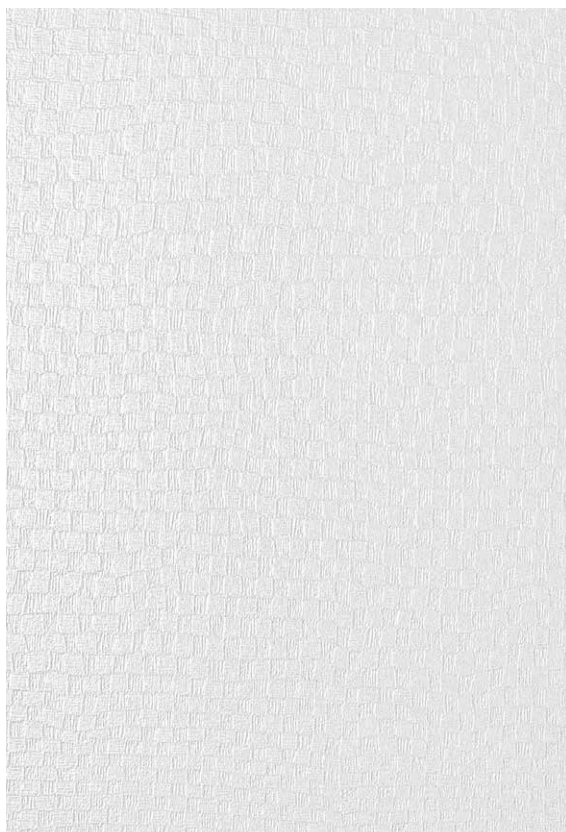

0090 White - Nava | Avant



0988 Sabbia - Nava | Avant

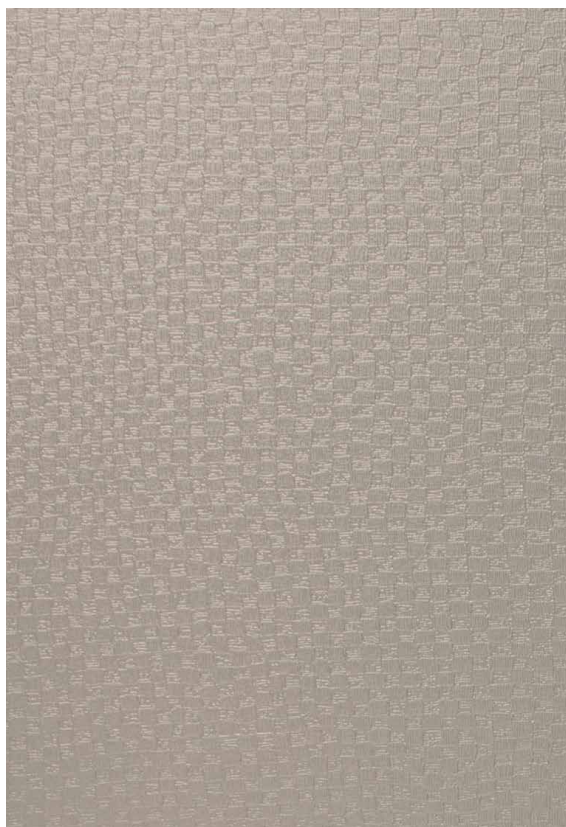

0494 Lapis - Nava | Avant

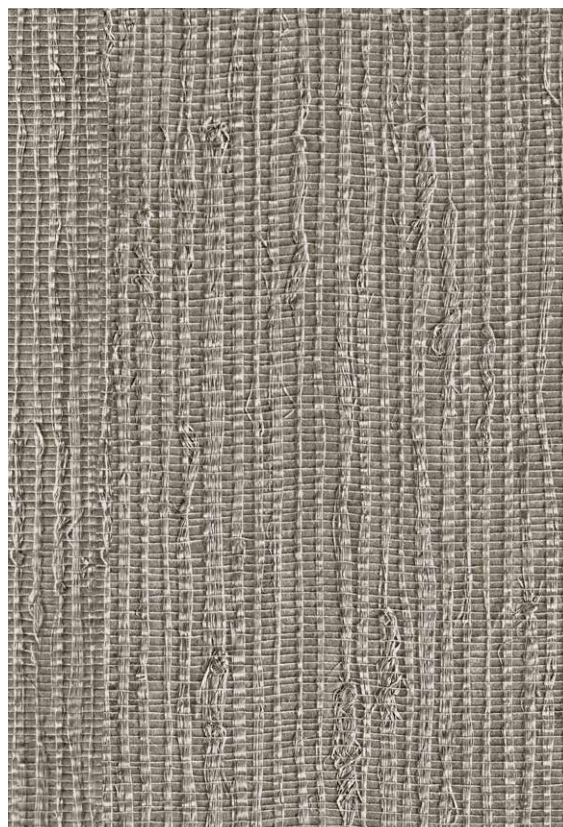

5170 Tapis Grey - Nava | Avant



9630 Tapis Beige - Nava | Avant



5150 Tapis Light- Nava | Avant

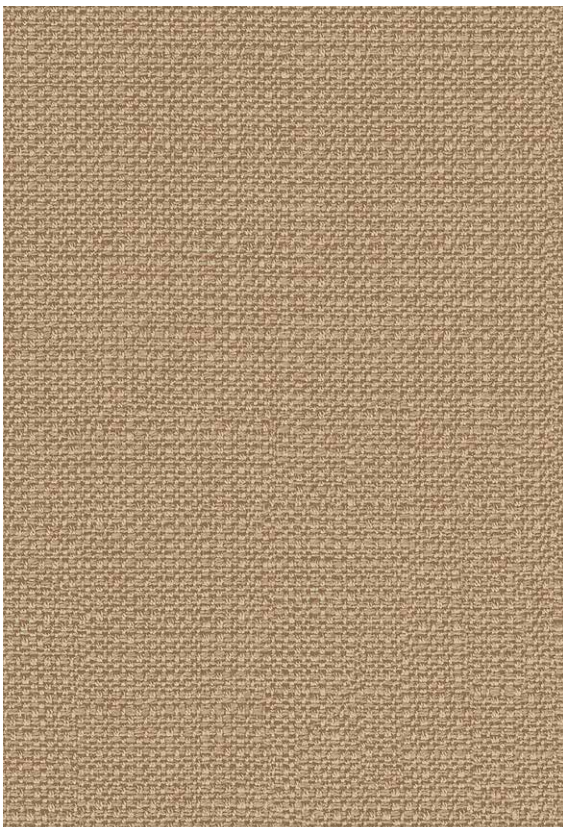

5190 Nodi - Nava | Avant



5210 Nodi Grey - Nava | Avant

TEXTILE



5140 Tapis Brown - Nava | Avant

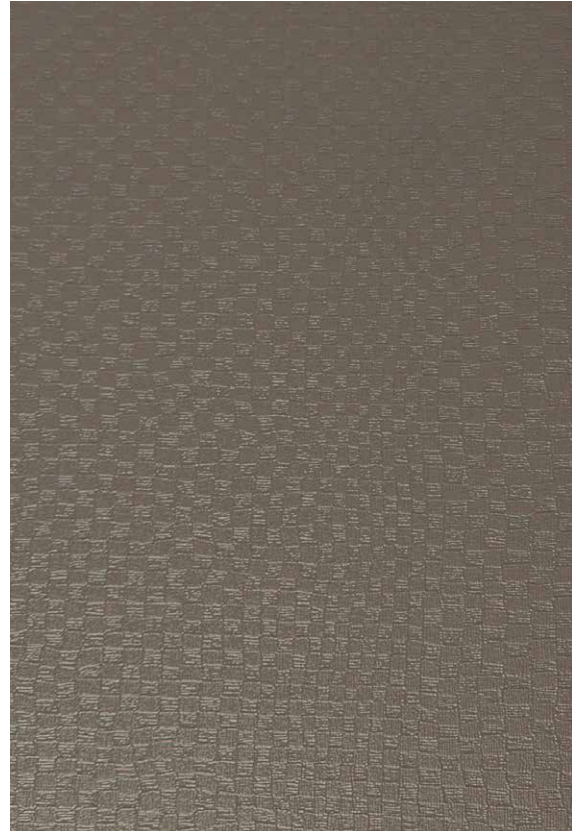

0694 Cement - Nava | Avant

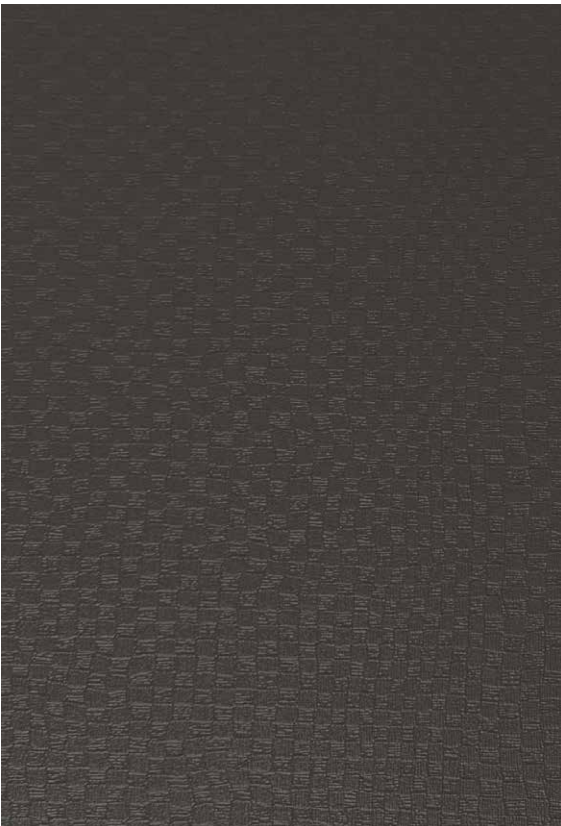

0074 Graphite - Nava | Avant



5160 Tapis Dark Grey - Nava | Avant

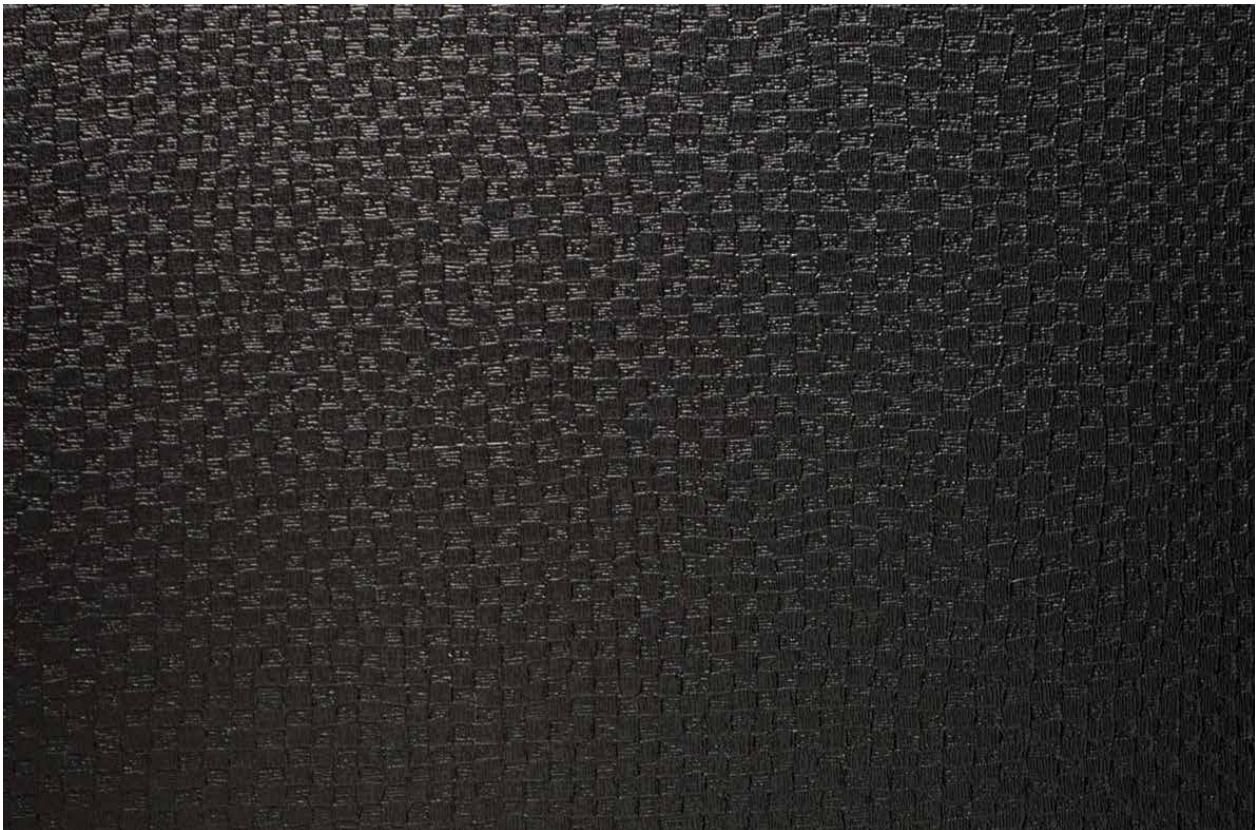

0070 Black - Nava | Avant

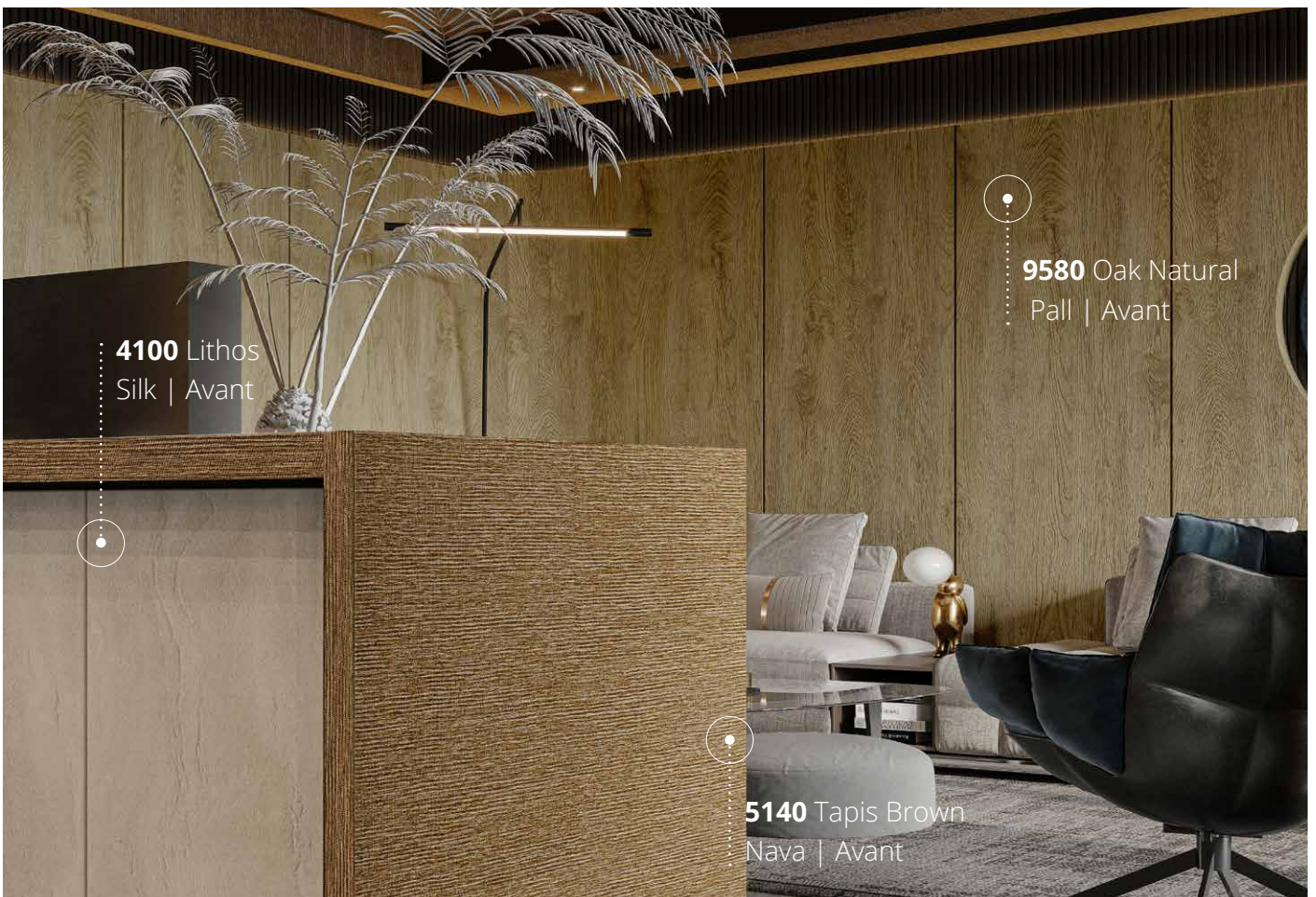

4100 Lithos
Silk | Avant

9580 Oak Natural
Pall | Avant

5140 Tapis Brown
Nava | Avant

Mineral materials

Extremely innovative solutions in textured designs, in marble, stone, cement, solutions, where the excellent imitation of raw material gives a unique style to your space.



MARBLE



2010 Biancol Marmo - Terra | Premium



2011 La Villa Marble - Terra | Premium

CEMENT



7502 Metropolitan - Soft | Natural



1194 Concrete - Soft | Natural

STONE

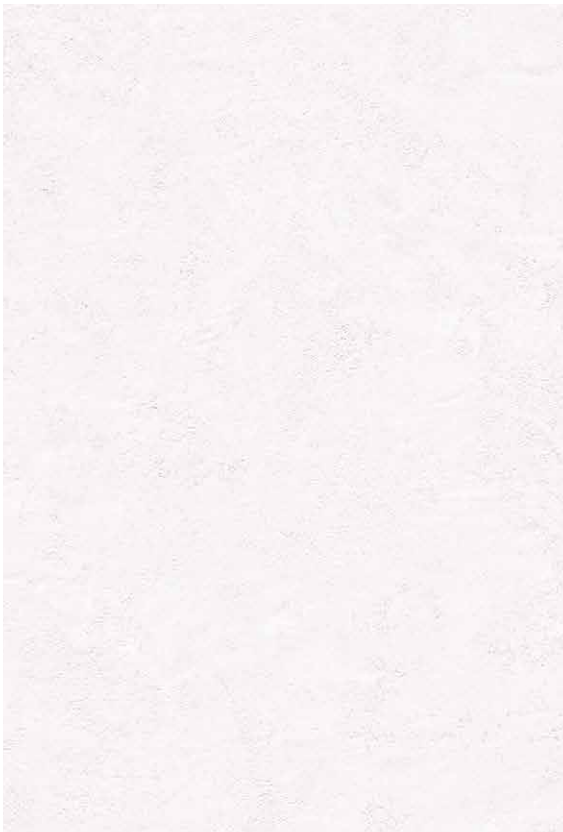

0090 White - Terra | Premium

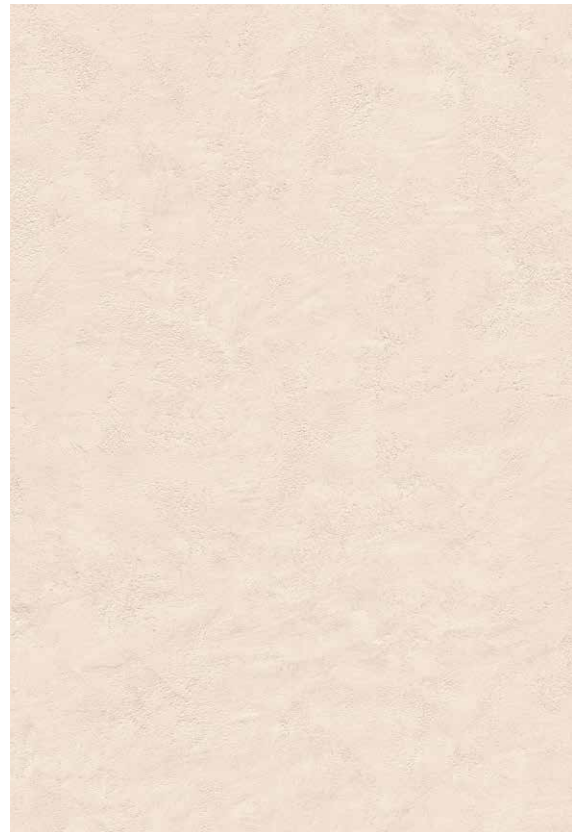

0988 Sabbia - Terra | Premium

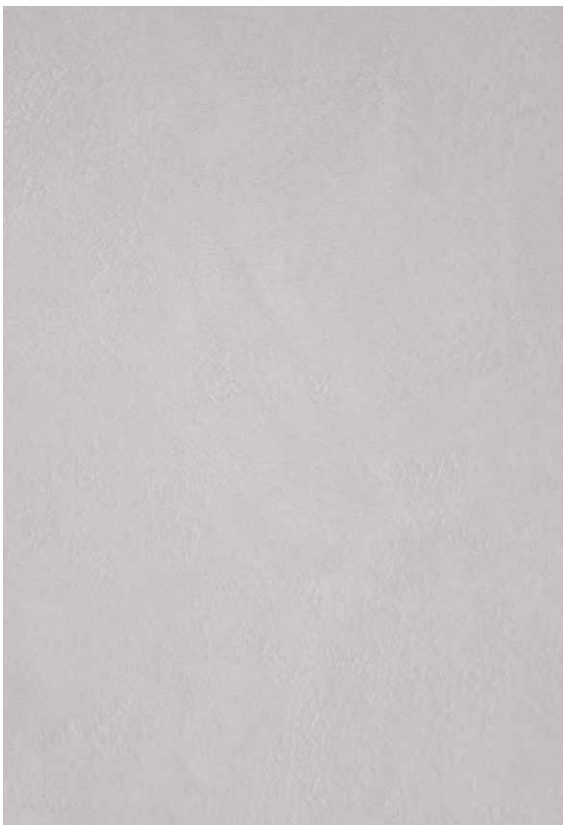

2012 Cloud Grey - Terra | Premium

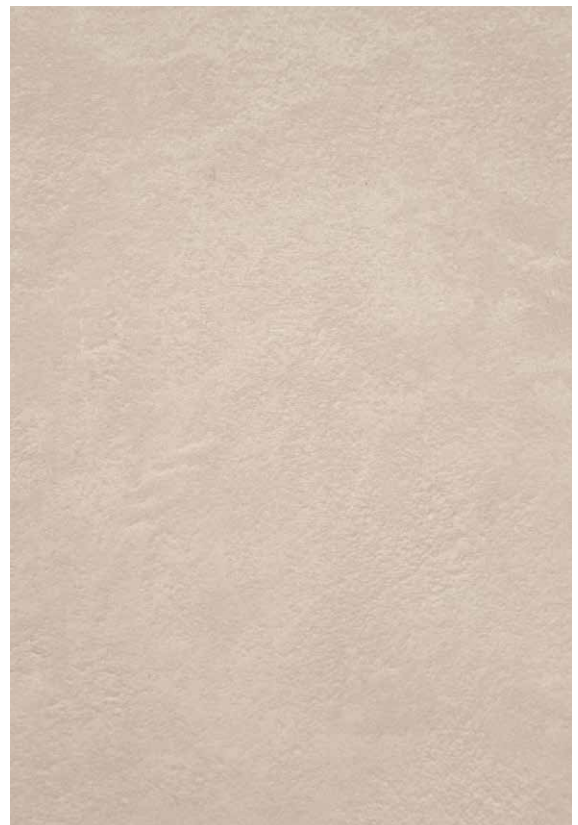

2013 Ivory Perla - Terra | Premium



2050 Marmo Grey - Terra | Premium

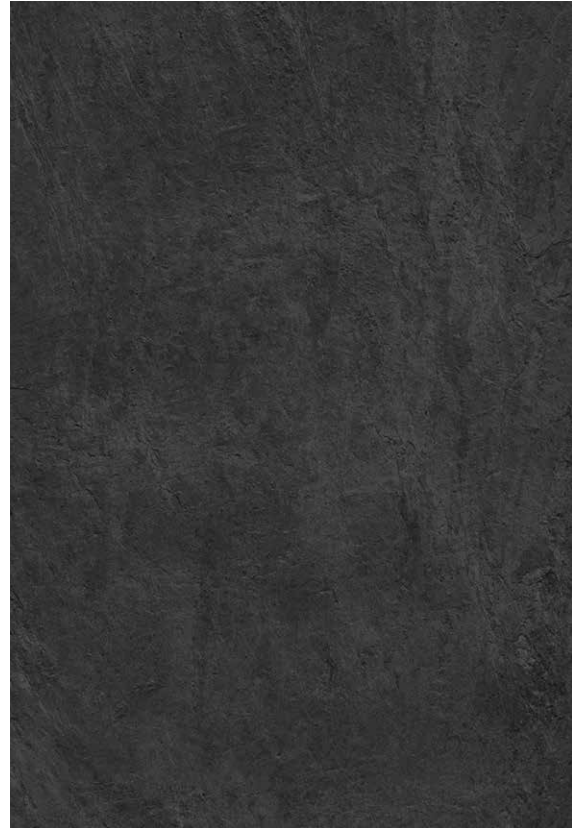

2060 Marmo Dark Grey - Terra | Premium



2070 Marmo Copper - Terra | Premium



2080 Marmo Nero - Terra | Premium

STONE



2014 Greige - Terra | Premium



0494 Lapis - Terra | Premium



2015 Tan Perla - Terra | Premium



2017 Taupe - Terra | Premium



2016 Misty Grey - Terra | Premium



0694 Cement - Terra | Premium

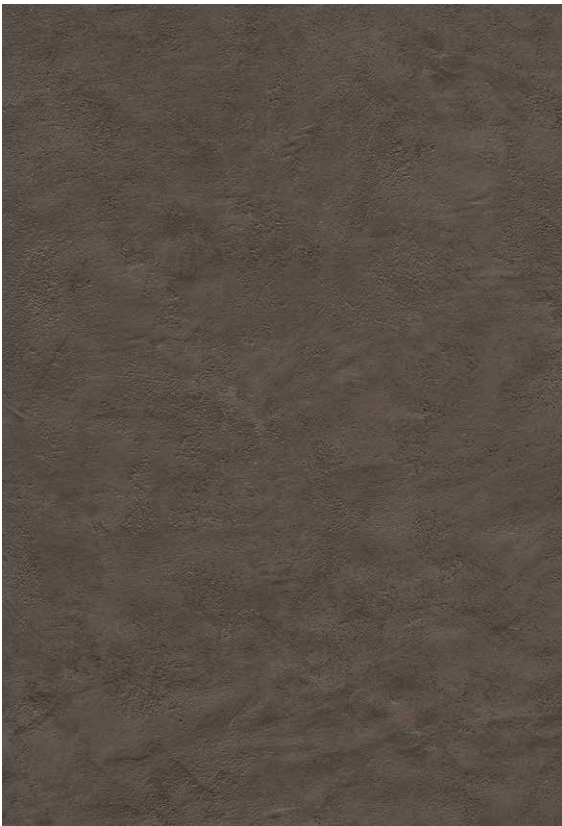

0074 Graphite - Terra | Premium

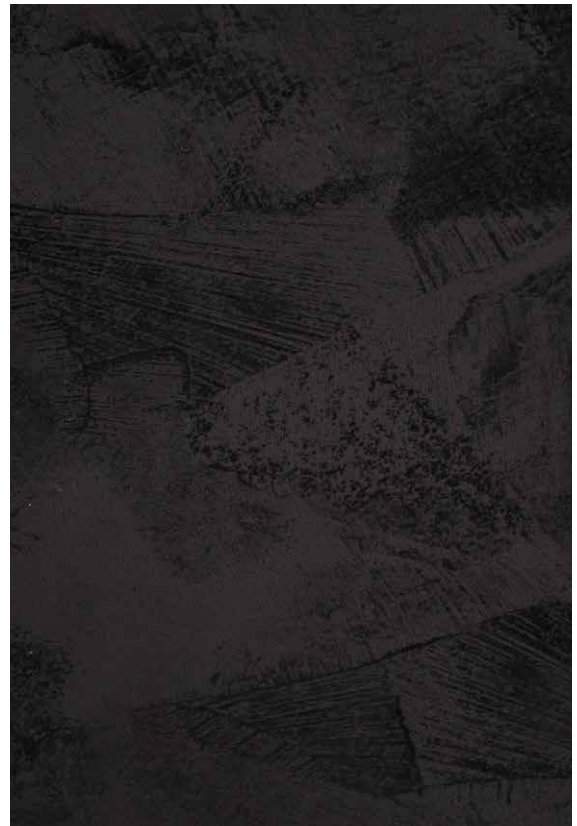

0070 Black - Terra | Premium

Metal

Discover the brushed aluminum imitation textures that represent a new aesthetic, a unique material for many applications in interior design projects.

The metallic look gives a sense of elegance to anything from decorative elements and fabrics, to furniture and entire interior projects.

Our metallic imitation Rada series includes 10 exclusive designs, that reflect the definition of modern.



METAL

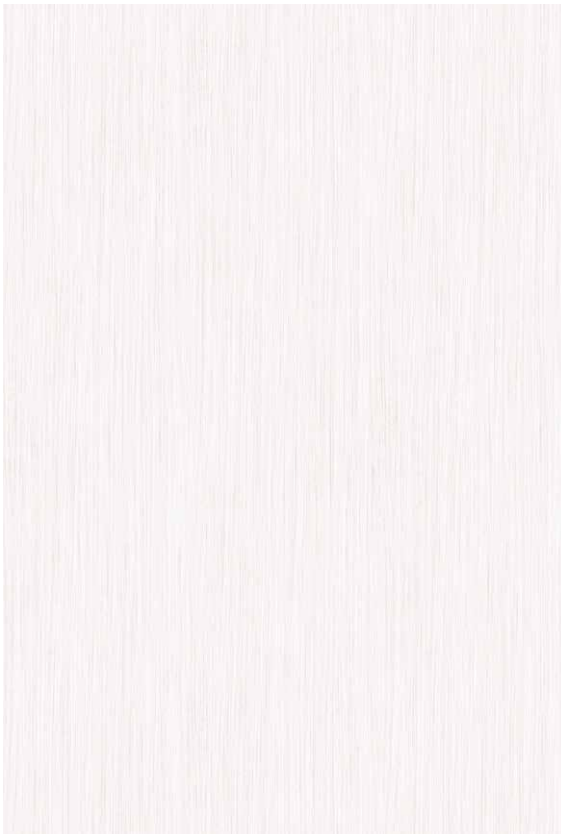

0090 White - Rada | Premium



3013 Lucent - Rada | Premium



3010 Tawny Rays - Rada | Premium



3014 Aktina - Rada | Premium

METAL



3015 Shiny Grey - Rada | Premium



3016 Splendor - Rada | Premium

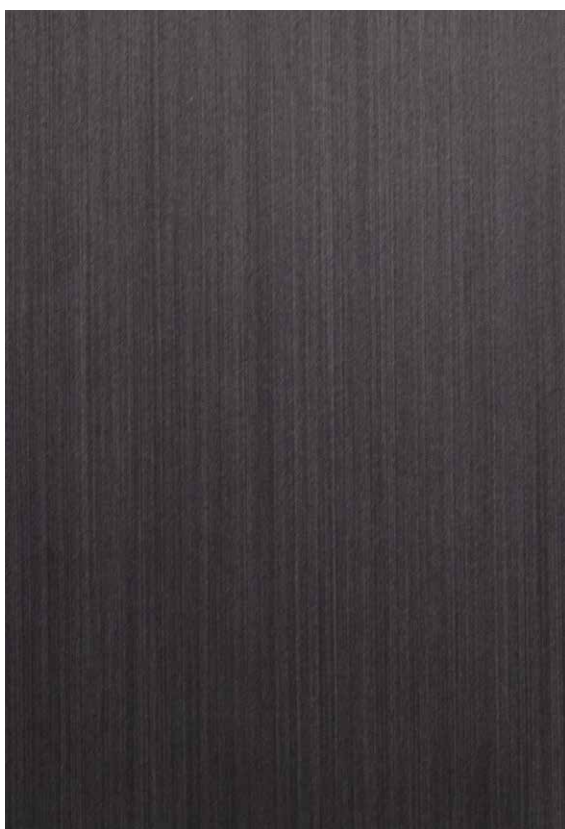

3017 Glamour - Rada | Premium

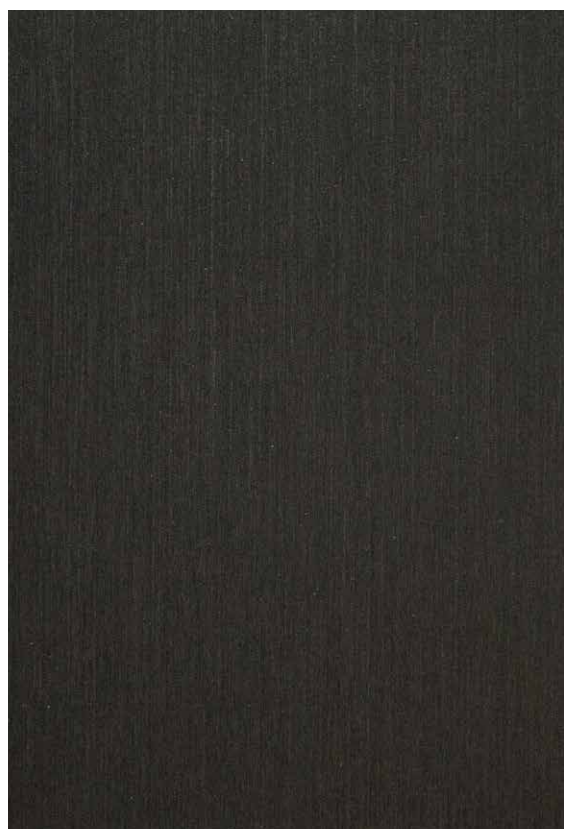

0070 Black - Rada | Premium



Gloss & Matt Surfaces

These panels are the result of an innovative processing technology that aims to push the boundaries in performance, aesthetics and sustainability. These panels' core is consisted of 2-sided HDF.

The front side is covered with acrylic sheets (super gloss-super matt) or pet (pet gloss - pet matt) while the back side is in the same colored melamine. Gloss and Matt - in a wide range of colors.

Super gloss & super matt are anti-scratch & anti finger.

1176 Sahara
Pet Gloss

SUPER MAT

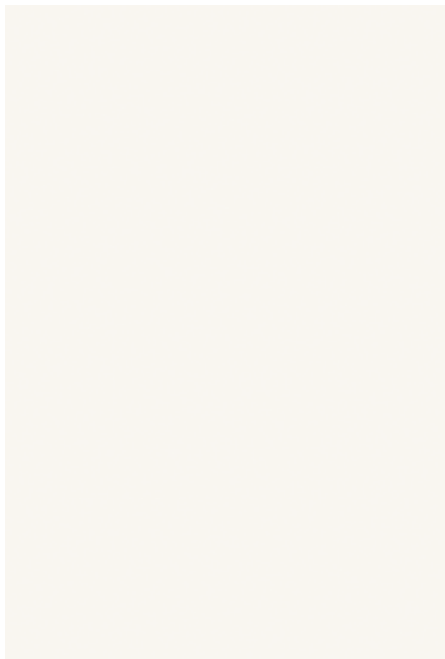

0340 White - Matt

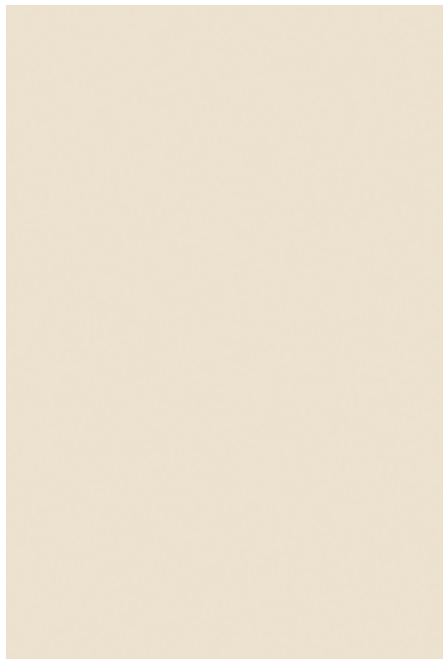

0337 Magnolia - Matt



0335 Sand - Matt



0336 Sand Grey - Matt



0338 Lava - Matt

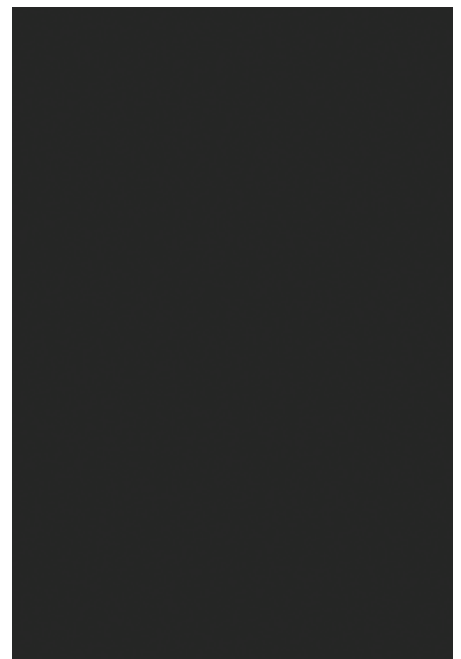

0330 Black - Matt

PET MATT

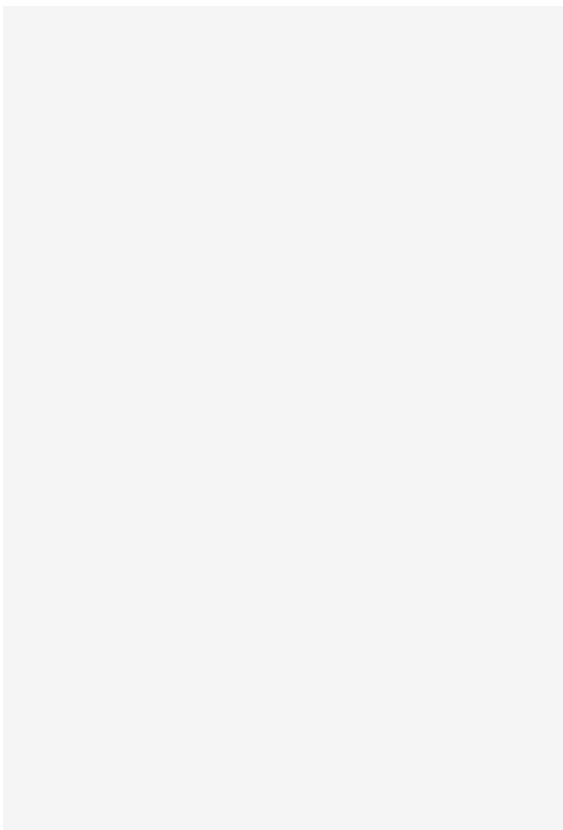

1298 Alaska White - Matt

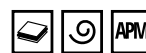
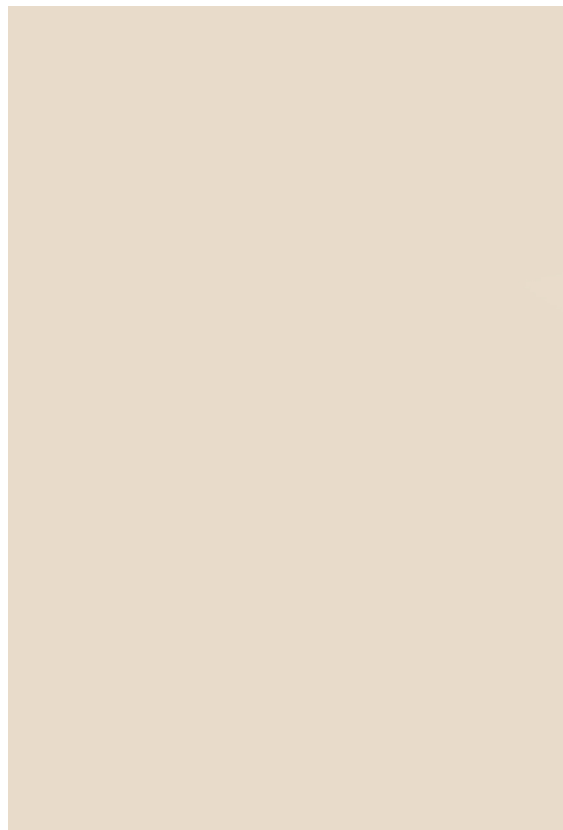

7315 Beige - Matt



1127 Pearl Grey - Matt

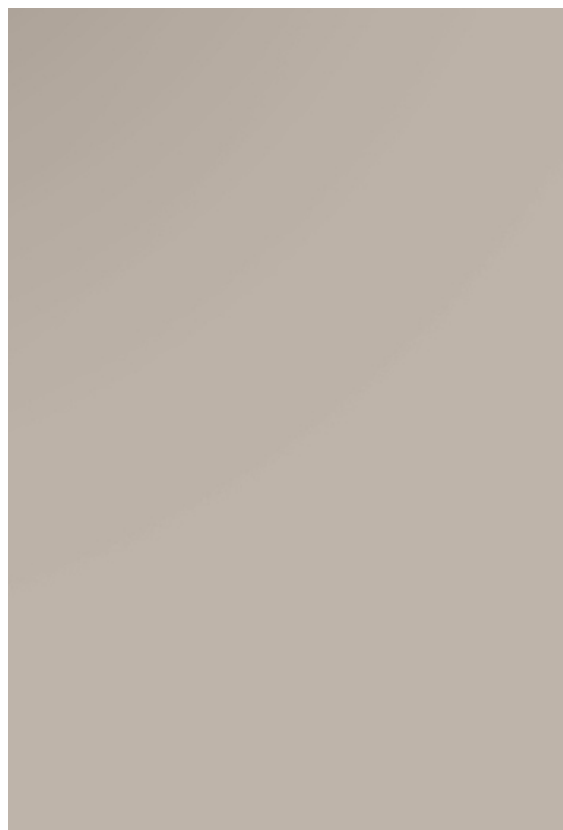

1176 Sahara - Matt



1148 Stone Grey - Matt



5881 Dusk Blue - Matt



5867 Ocean Blue - Matt



5864 Lichen Green - Matt

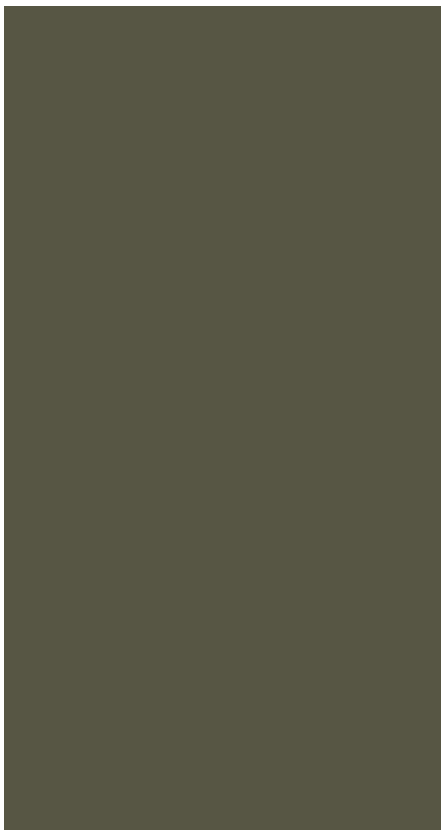

5883 Smoke Green - Matt

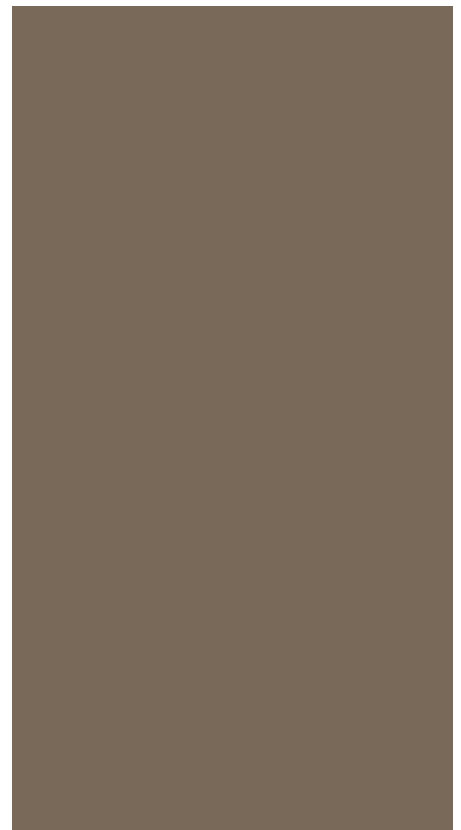

5852 Latte - Matt

PET MATT



2344 Clay - Matt

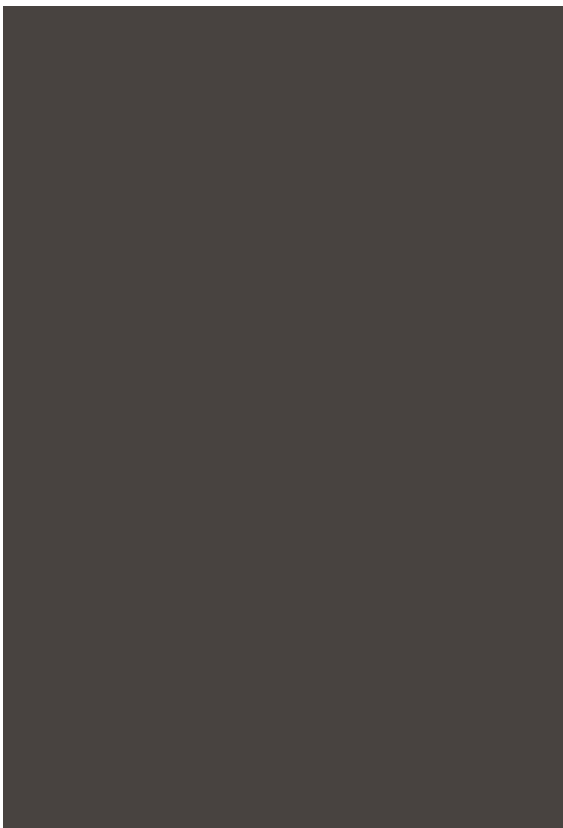

1169 Wolfram Grey - Matt

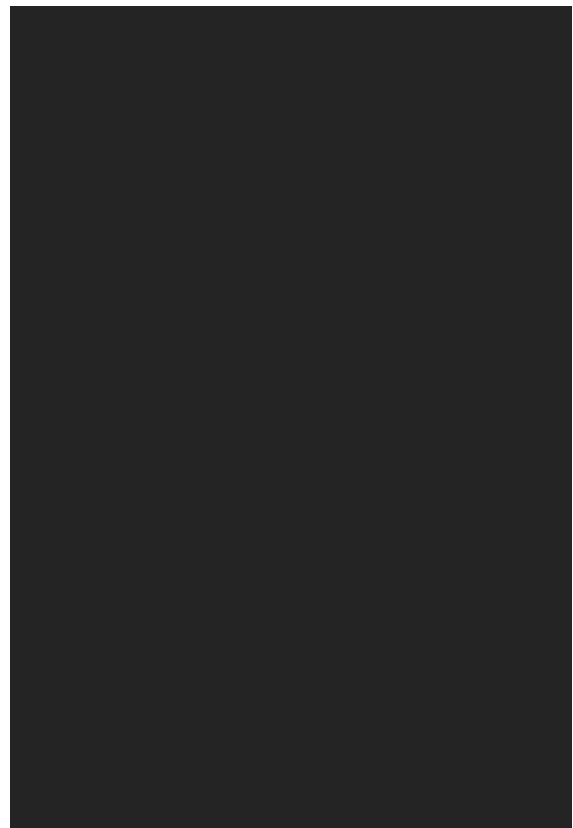

8102 Black - Matt



1169 Wolfram Grey
Pet Matt



1298 Alaska White
Pet Matt



9686 Gloss
Exclusive

PET GLOSS

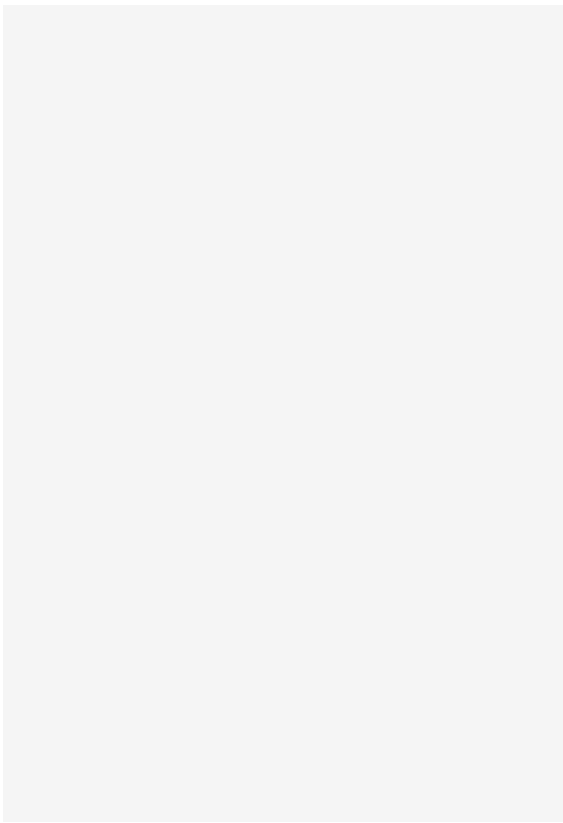

1298 White - Gloss

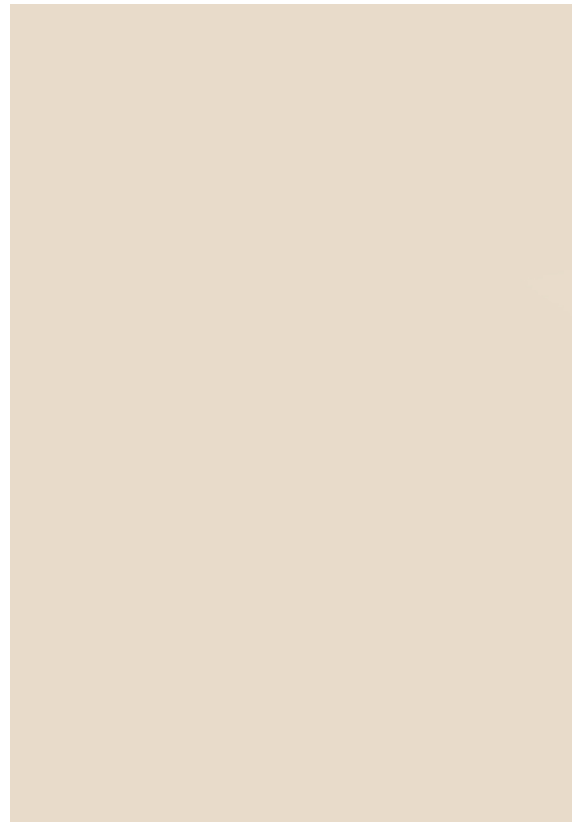

7315 Beige - Gloss



1127 Pearl Grey - Gloss



1176 Sahara - Gloss

PET GLOSS



1148 Stone Grey - Gloss



1169 Wolfram Grey - Gloss



8102 Black - Gloss

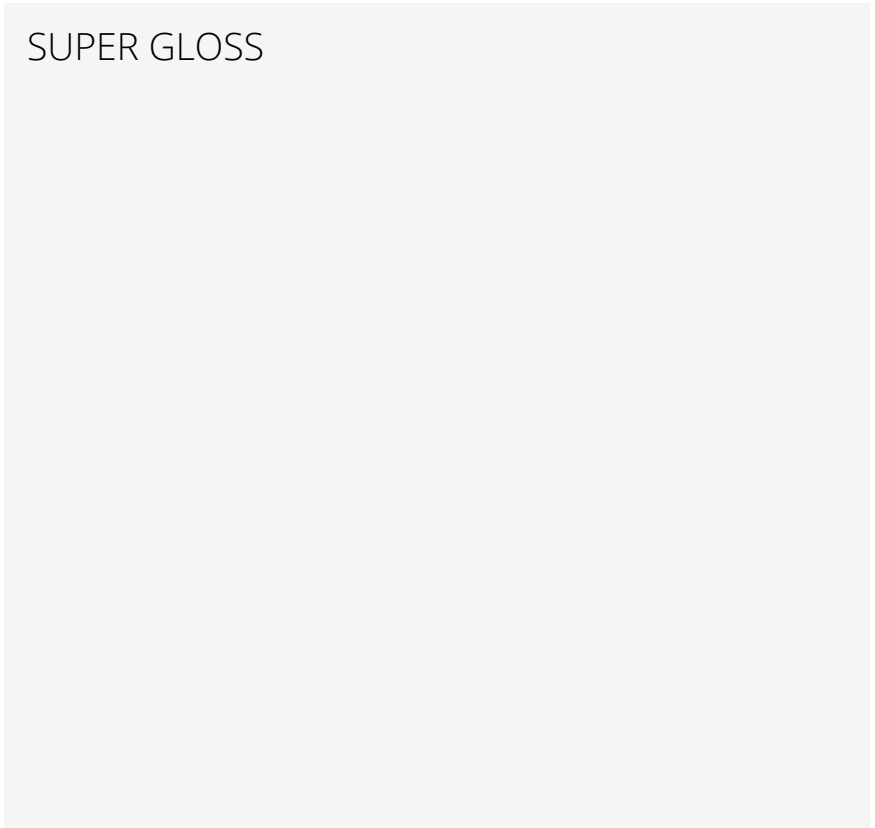

1298 White - Gloss



Kitchen Worktops

The high quality and durability of our countertops make them ideal for your kitchen, bathroom, office or store.

The surface textures are stone, granite, marble & wood imitation with many combinations in shades and textures to choose from and create an individual quality style.

Features

- Impact resistant
- Abrasion resistant
- Stain resistant
- Strong resistance to UV rays
- They do not discolor
- Protection against bacteria
- Easy to clean
- Eco friendly raw materials

Formaldehyde emission category **E1**

APPLICATIONS WORKTOP



U 19mm
Black Core



U 28mm



U 38mm

E1 NON-CARCINOGENIC
RAW MATERIALS



ABRASION
RESISTANCE



IMPACT
RESISTANCE



ACID
RESISTANCE



EASY TO
CLEAN



DURABILITY
OVER TIME



RESISTANCE
TO MOISTURE



RESISTANCE
TO SUNLIGHT



TENSILE
STRENGTH



RESISTANCE TO
SCRATCHING



RESISTANCE TO
EXTREME TEMPERATURES

Solid colors

Combinations of solid color kitchen worktops with matt or gloss texture are the most popular and provide a unique end result.



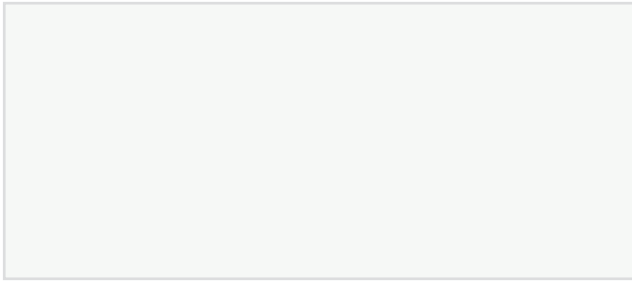

U 1027 Matt - Exlusive



U 1184 Matt - Exlusive



U 1193 Matt - Exlusive

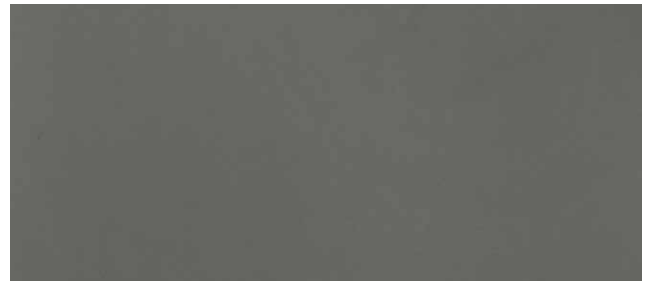

U 1290 Matt - Exlusive

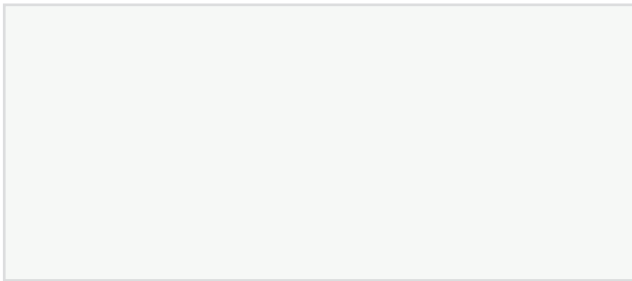

406 L Gloss - Exlusive



421 L Gloss - Exlusive



0406 Matt - Standard

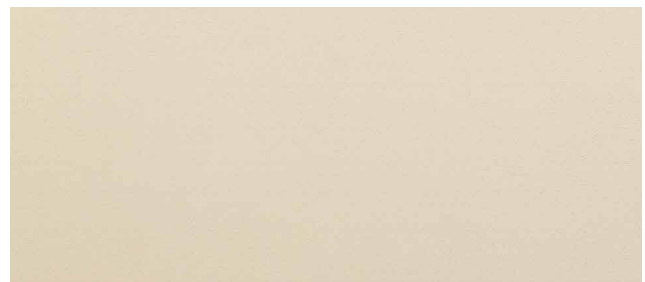

0088 Matt - Standard



Stone & Cement

Stone or cement imitation worktops are extremely innovative, provide modern kitchen solutions and can be combined with dark or light colored surfaces for contrast and a unique end result.

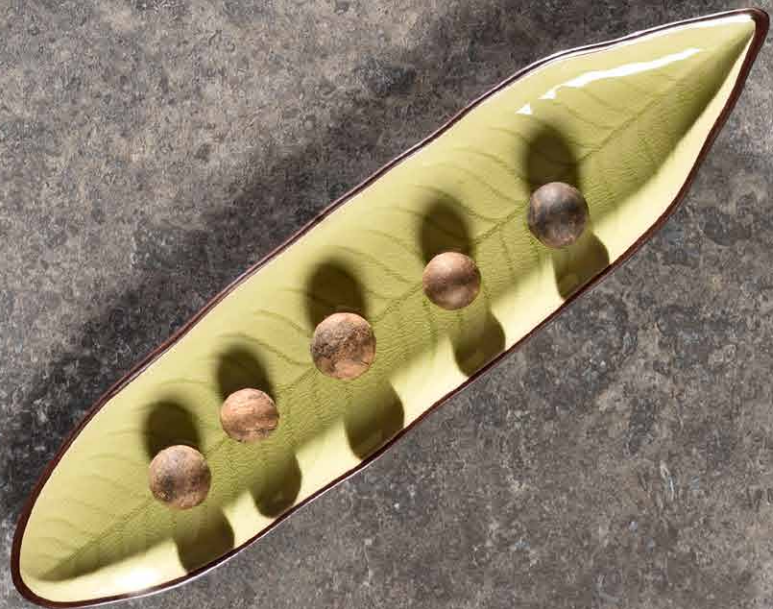



5096 Exclusive



5105 Exclusive



5110 Exclusive

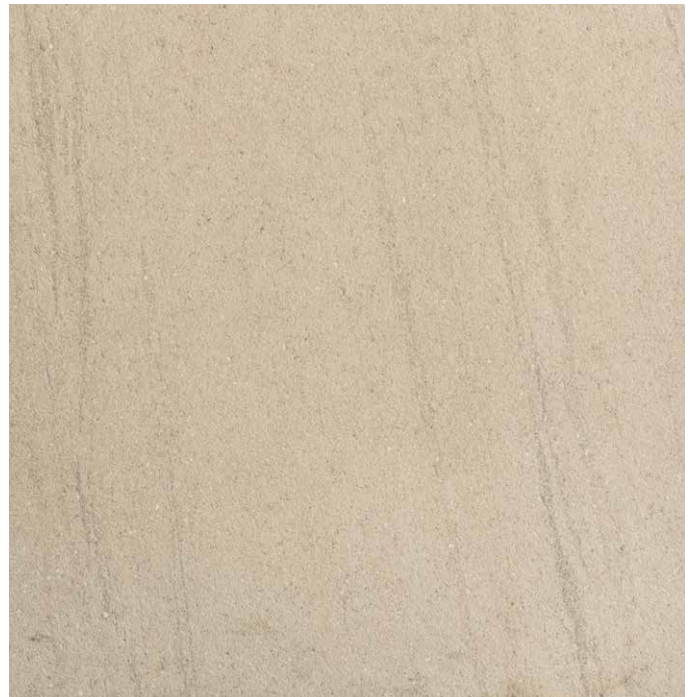

5634 Exclusive



STONE



5063 Exclusive



5120 Exclusive



3324 Exclusive



5099 Matt - Exclusive



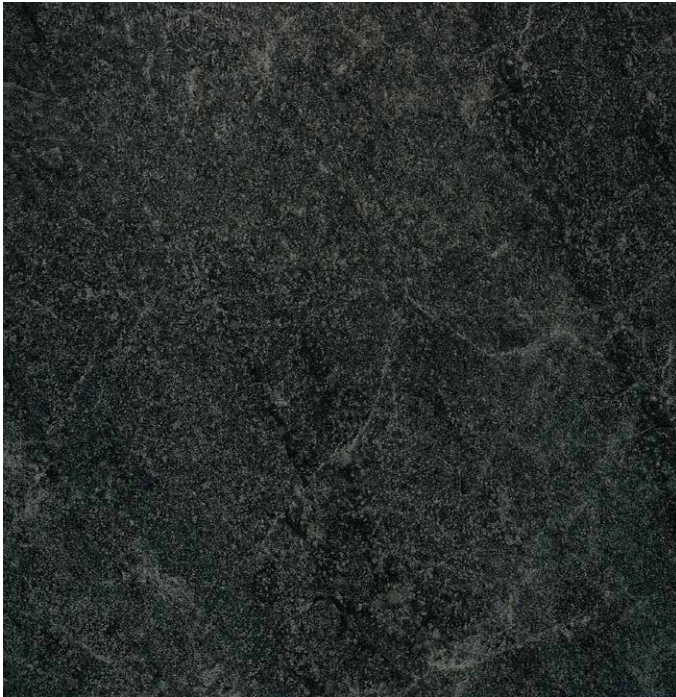

5025 Standard



3329 Exclusive



3181 Matt - Exclusive



Marble

Kitchen worktops with marble or granite imitation can create an authentic high aesthetic.



MARBLE



5657 Gloss - Exclusive **

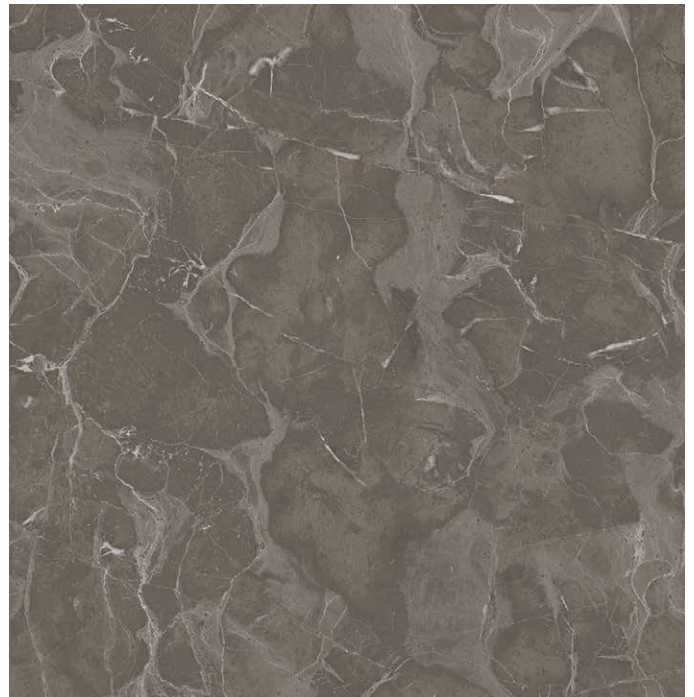

5746 Touch & Gloss - Exclusive **

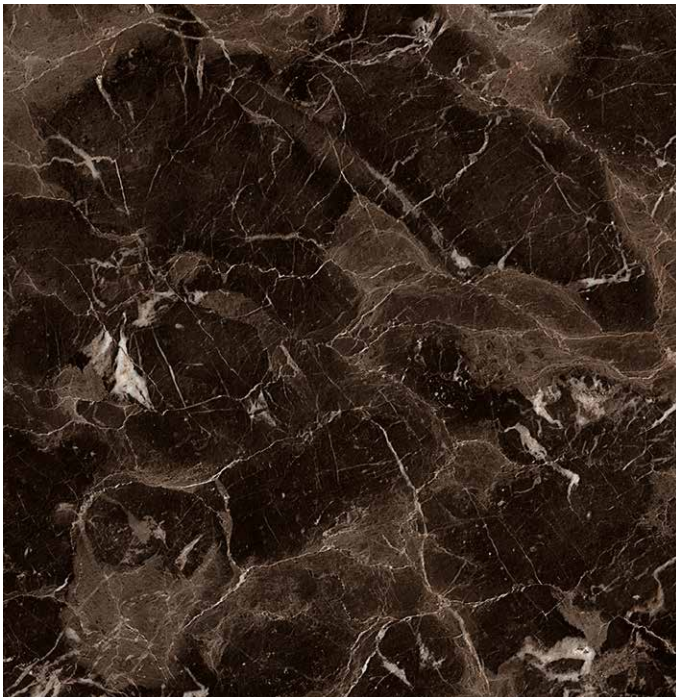

5658 Gloss - Exclusive **



9686 Gloss - Exclusive **



** Also in 19mm Black Core

MARBLE



12 L Touch - Exclusive



15 L Touch - Exclusive



F 6811 Stone - Exclusive

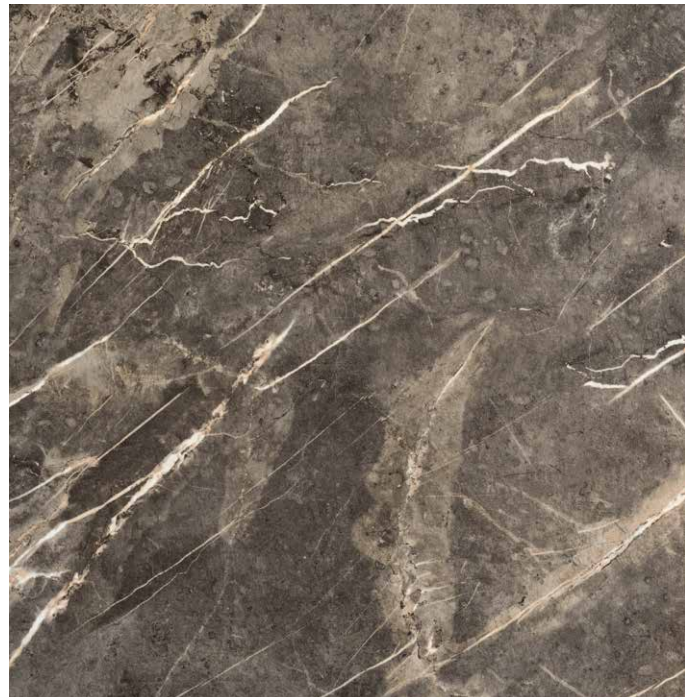

F 6812 Stone - Exclusive **



** Also in 19mm Black Core



F 6813 Soft - Exclusive **



F 6821 Soft - Exclusive



3179 Matt - Exclusive



6254 Matt - Standard



1090 Matt - Standard



TV 374 Matt - Standard



585 Matt - Standard



Metallic

The metallic worktops are very impressive, as the Gloss effects create unique patterns.

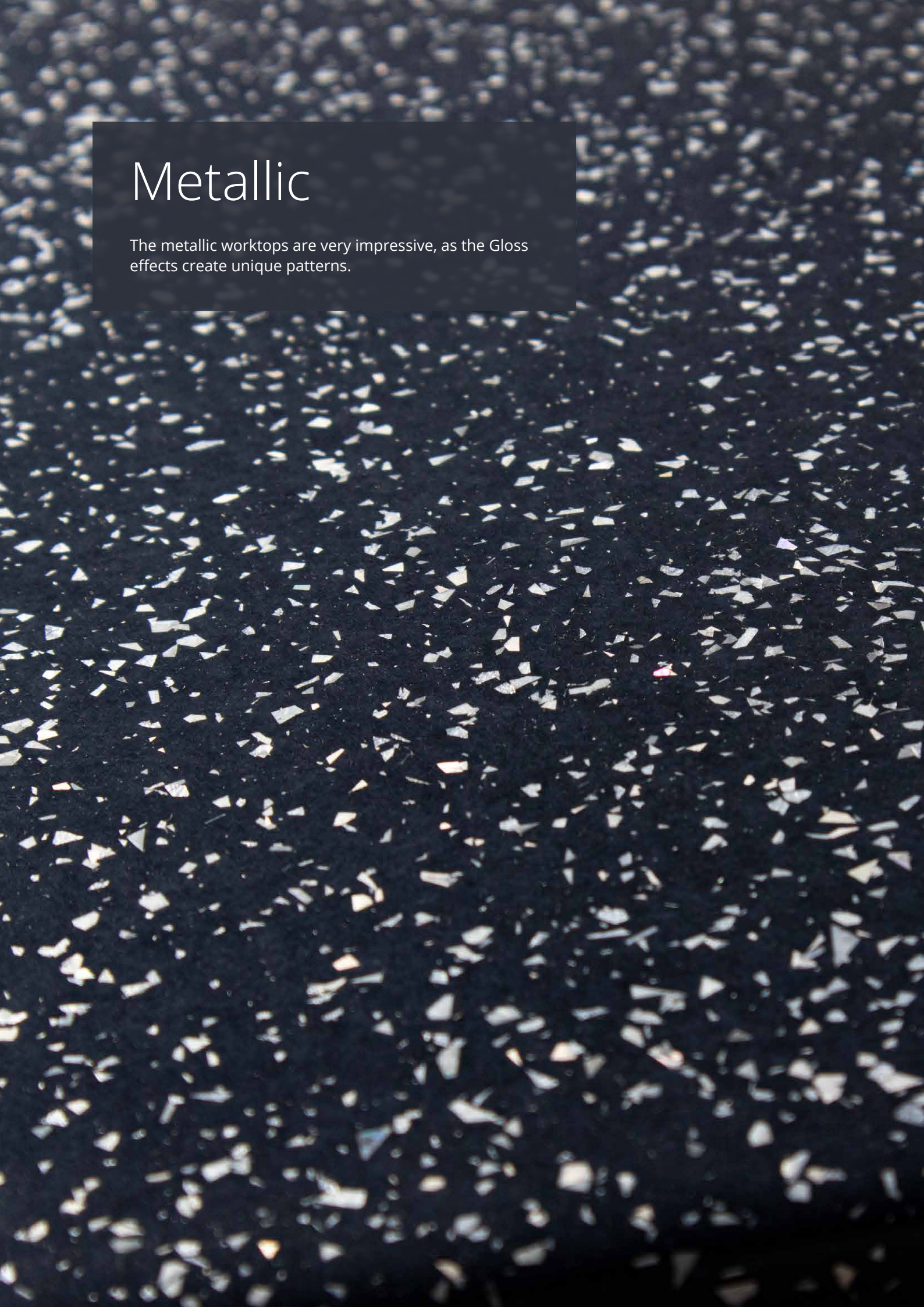

METALLIC

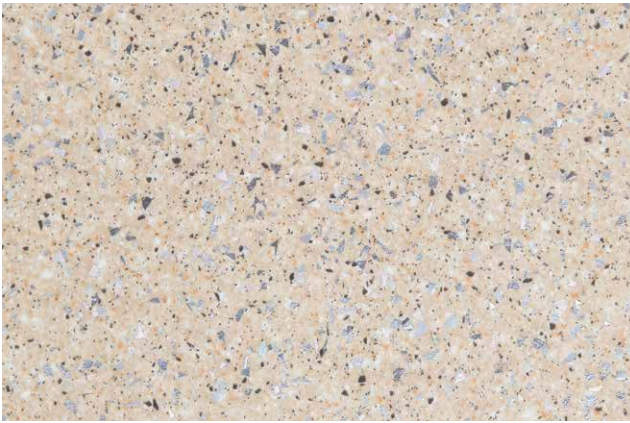

S 5029 Metallic - Exclusive*



S 015 Metallic - Exclusive*



S 001 Metallic - Exclusive*

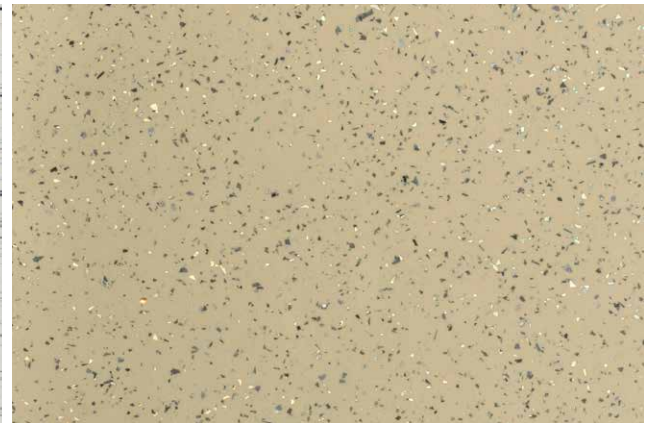

S 003 Metallic - Exclusive*



M 012 Metallic - Exclusive



M 010 Metallic - Exclusive



3308 Matt - Standard

* ABS Edge Banding

Wood

Kitchen worktops with a natural wood imitation, will give your kitchen a perfect look according to modern trends requirements.



wood



4509 Touch - Exclusive



4672 Touch - Exclusive



4675 Touch - Exclusive



24 L Touch - Exclusive



3180 Matt - Exclusive



3171 Matt - Exclusive



3164 Matt - Exclusive



5101 Stone - Exclusive



3167 Matt - Exclusive

ALFA COMBO

The ultimate combination of countertops and decorative surface!

Alfa Wood Group curated the design of the textures and color tones of the kitchen worktops (ALFA TOPS) for decorators, architects, mechanics & consumers who demand uniformity in their space.

The new Collection Exclusive Combo is the ideal decoration solution for their kitchen. The new countertops have the particularity of being perfectly combined with the corresponding decorative surfaces (ALFA SURFACES).



ALFA COMBO



2010 Biancol Marmo - Terra **



2011 La Villa Marble - Terra **



2016 Misty Grey - Terra



0494 Lapis - Terra **



** Also in 19mm Black Core

ALFA COMBO



0694 Cement - Terra



0074 Graphite - Terra **

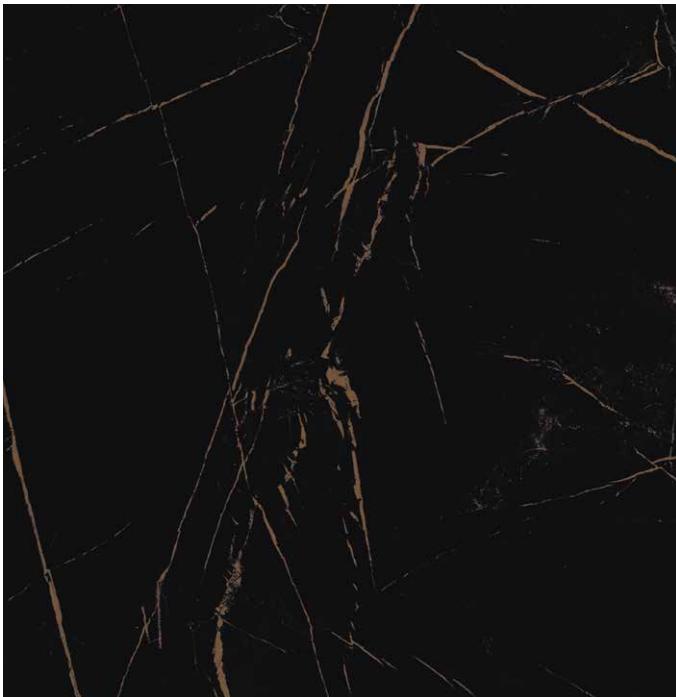

2080 Marmo Nero - Terra



8502 Elvezia Rovere - Brushed Wood



** Also in 19mm Black Core

ALFA COMBO



1406 Dark Pine - Brushed Wood



9322 Elm Bright - Brushed Wood



9323 Elm Dark - Brushed Wood



8702 Brooklyn Brown - Brushed Wood



9310 Noce Lirico - Brushed Wood



3501 Winchester Walnut - Brushed Wood

** Also in 19mm Black Core



ALFA COMPACT

ALFA COMPACT are compact panels suitable for rooms with high humidity rates, due to their special production process. It is an innovative new generation product that is durable, antibacterial and easy to clean.

Recommended for applications where high impact resistance is required. It is preferred in areas that accumulate a lot of moisture such as cupboards & toilets. Available in a variety of colors and finishes for all residential and commercial spaces such as homes, offices, restaurants, schools, gyms, public transportation vehicles, table tops, hospitals as well as wall coverings.

Advantages

- Highly water resistant
- Highly resistant
- Doesn't decompose
- Doesn't decompose
- Highly scratch resistant
- Highly fire resistant

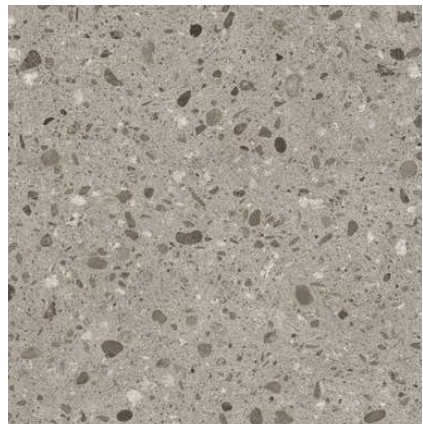
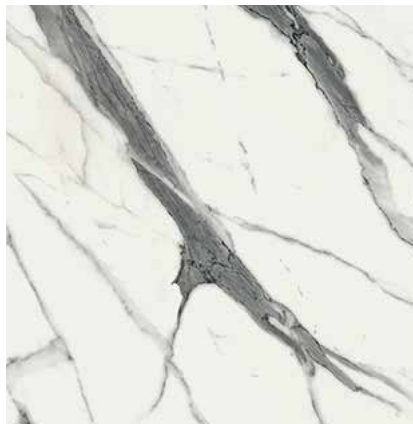
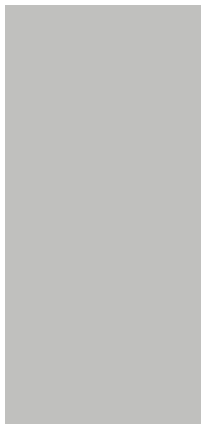
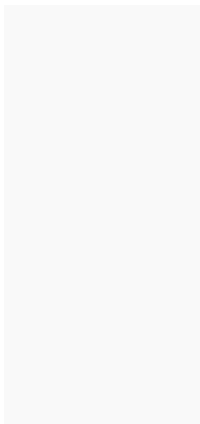
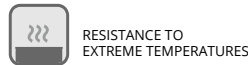
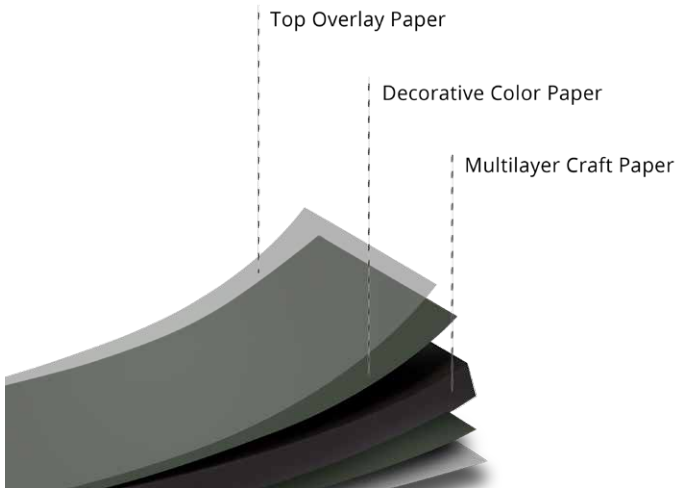

3095 Esse

3305 Touch

5657 Touch & Gloss

5767 Touch

ALFA COMPACT



3299 Touch



5736 Touch



5746 Touch



5743 Touch



5717 Gloss

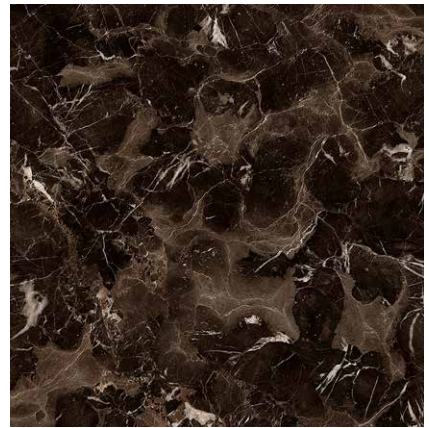

5658 Gloss



9686 Touch & Gloss



5741 Gloss



3190 Touch



Environment

Sustainable Forestry

Our supply chain is centered around the protection of and care about the environment, contributing to the sustainable management of forestry.

Timber is supplied exclusively from controlled sources, verified by the certified government agencies (Forestry divisions/ forestry inspectorates) as well as international organisations such as FSC®. During the production process, we opt for internationally certified management systems such

as quality management, low formaldehyde emission, fire and moisture resistance. ISO 9001: 2015, CE, FSC, CARB, E0, FIRE RETARDANT AND MOISTURE RETARDANT.

• End product reaches the consumer in full transparency, according to the Environmental Product Declaration (EPD), which provides important information on the environmental and health aspects of the manufacturing process for each of our key products.

• All wood processing by-products deriving from the production process, as well as those not suitable for sale, are re-processed and used either for new wood panel production or for biomass energy production, depending on their origin.

• In the meantime, biomass, through the combustion process, generates heat as well as “green electricity”.

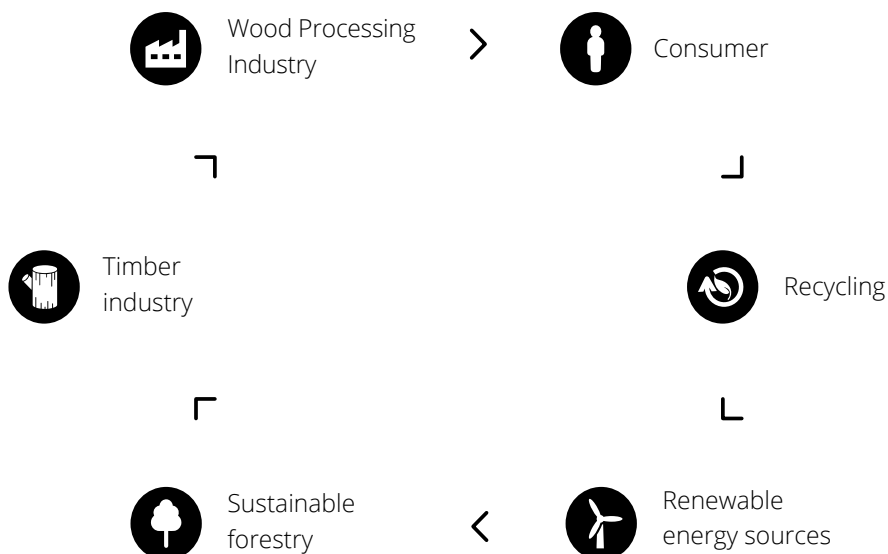

Statistics



Annual production dynamics

- / Power generation **6.5 MW**
- / Pellet production: **60.000 tons**
- / Briquette: **7.000 tons**
- / Raw fiberboard: **100.000 m³**
- / Melamines: **9.100.000 m²**
- / Coated sheets with veneer: **1.100.000 m²**
- / Kitchen countertops: **340.000 m²**
- / Lacquered fiberboard: **10.000 m³**
- / Acrylic: **240.000 m²**
- / Laminate flooring: **700.000 m²**
- / Door frames: **300.000 m**
- / Profiles: **730.000 lm**
- / Frames: **730.000 lm**
- / Interior doors: **12.000pcs**

Certifications

We ensure the best possible management of our turnover for the least environmental impact possible.

Our certifications ensure our commitment to the least environmental impact possible.

With viable practices and the goal of sustainability, we take care of the environment that takes care of us.

Our goal: the least environmental impact possible

We supply wood-based products certified by the Forest Certification Approval Program (FSC®).

For our production cycle we use wood from rationally managed forests, which ensures a renewable and sustainable resource.

Together along with our suppliers, we strive to achieve the least possible environmental impact.



ISO 9001: 2015
Quality assurance
certification.



E1:
Certification
for emitted
formaldehyde limits.



CE:
European Compliance
Conformité Européenne



Bfl-s1:
Fire resistance index
Certification for
fire-resistant products



The Forest Stewardship Council™ (FSC™) is a global, not-for-profit organization dedicated to the promotion of responsible forest management worldwide. FSC defines standards based on agreed principles for responsible forest stewardship that are supported by environmental, social, and economic stakeholders. FSC™ helps take care of forests and the people and wildlife that call them home.



CARB/EPA: Certification for MDF production. CARB / EPA products are specially designed fiberboards with reduced formaldehyde emission.



EN Plus A1, EN Plus A2:
Certification for pellets according to the European high
quality standard ENplus.

Symbol Key



CHIPBOARD



HPL



COMPACT



LACQUERED



ACRYLIC SUPER GLOSS



ACRYLIC SUPER MATT



ACRYLIC PET GLOSS



ANTIBACTERIAL



ACRYLIC PET MATT



WORKTOPS



SPLASHBACKS



DOORS



FRAMES



EDGE BANDINGS



PROFILES

**“from nature
to mankind,
with care
and love”**



ALFA WOOD GROUP

CONTACT DETAILS

Industrial Area of Larissa - Greece
+30 2410 561222

info@alfawood.gr | www.alfawood.gr



CONTACT DETAILS

Industrial Area of Larissa - Greece
+30 2410 561222

info@alfawood.gr | www.alfawood.gr